

Produktu cenrādis

Cenas spēkā no 19.03.2024.

Izmēru tabula

Visi norādītie izmēri attiecas uz ārējo rāmi, nevis uz stikla paketi (platums x augstums mm).

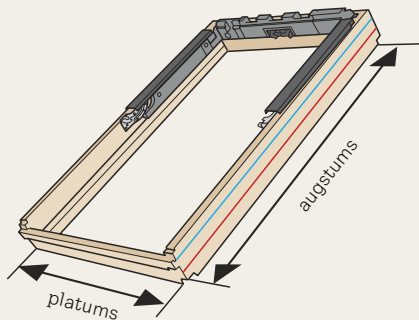

VELUX jumta loga modelis

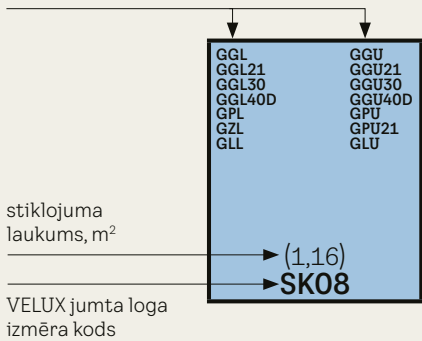

Jumta logi

550				GGL GGL21 GGL30	(0,27) PK25			
624				GGL	(0,26) MK27			
698	GGL GGL21	(0,19) CK01				GGL GGL21 GGL30	(0,48) SK01	
778	GGL21 GGL GGL30 GZL GGL21 GLL GGL30 GGU GGU21 GLU GGL30 GLU21 GLU30	(0,22) CK02						
978	GGL GGL21 GGL30	GGL GZL GGL21 GGU GGL30 GPL GGU21 GPU GGU30 GXU GLU/-B GLU/-B	GGL GGU GGL21 GGU21 GGL30 GGU30 GZL GLL	GGL GGU GGL40D GPU GPL GGL21 GPU GGL30 GPU GLL21 GPU21 GLU30	GGL GGU GGL40D GPU GPL GGL21 GPU GGL30 GPU GLL21 GPU21 GLU30	GGL GGL21 GGL30 GPL	GGL GGL21 GGL30 GPL	GGL GGL21 GGL30 GPL
1178	(0,23) BK04	(0,29) CK04	(0,38) FK04	(0,47) MK04	(0,60) PK04		(0,91) UK04	
1398	GGL GGL21 GGL30 GPL GZL GLL	GGL GGU GGL21 GGU21 GGL30 GGU30 GPL GPU GPU21 GLU/-B	GGL GGU GGL21 GGU21 GGL30 GGU30 GPL GPU GPU21 GLU/-B	GGL GGU GGL40D GGU40D GPL GPU GPU21 GLU/-B GLU/-B GLU30	GGL GGU GGL40D GGU40D GPL GPU GPU21 GLU/-B GLU/-B GLU30	GGL GGL21 GGL30 GPL	GGL GGL21 GGL30 GPL	GGL GGL21 GGL30 GPL
1600		(0,37) CK06	(0,47) FK06	(0,59) MK06	(0,75) PK06		(0,95) SK06	(1,15) UK06
1800				(0,58) FK08	(0,72) MK08	(0,92) PK08	(1,16) SK08	(1,40) UK08
				(0,85) MK10	(1,07) PK10	(1,35) SK10	(1,63) UK10	
				(0,97) MK12				
920			GIL GIU	(0,34) MK34	(0,44) PK34	(0,70) SK34	(0,85) UK34	
601			VFE VIU	(0,22) MK31	(0,28) PK31	(0,36) SK31	(0,43) UK31	
955			VFE VIU VFA VFB	(0,44) MK35	(0,56) PK35	(0,70) SK35	(0,85) UK35	
1155			VFE VIU VFA VFB	(0,56) MK36	(0,71) PK36	(0,89) SK36	(1,08) UK36	
1375			VFE VIU VFA VFB	(0,69) MK38	(0,87) PK38	(1,10) SK38	(1,33) UK38	
mm	472	550	660	780	942	1140	1340	

Vērtība iekavās norāda logu stiklojuma laukumu m²

Jumta balkons GDL

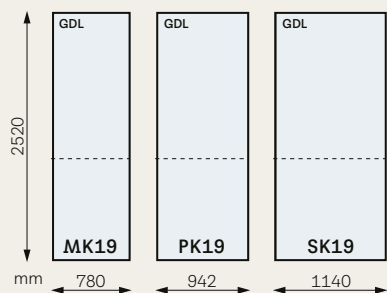

Jumta terase GEL

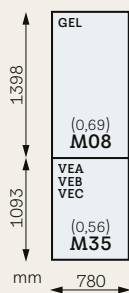

VELUX GGLS trīs vienā

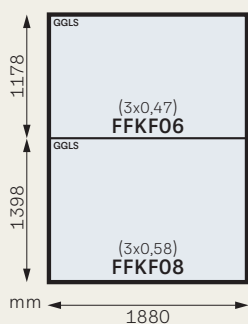

Jumta lūkas

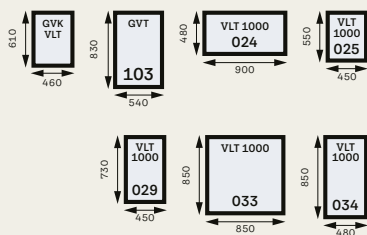

Virsgaismas logi

600	CFP CVJ CVP CFU CFJ CVU 060060	CFJ CFU CVJ CVU 090060			CFU CVU 200060
800	CFP CFU CVP CVU CFJ CVJ 080080				CFU CVU 150080
900	CFP CVP 060090	CFP CFU CVP CVU CFJ CVJ 090090		CFJ CVJ CFU CVU 120090	
1000			CFP CFJ CVP CVJ CXP CFU CSP CVU 100100	CFJ CVJ CFU CVU 150100	CFJ CVJ CFU CVU 200100
1200		CFP CVP CXP 090120		CFP CFJ CVP CVJ CXP CFU CSP CVU 120120	CFU CVU 150120
1500			CFP CVP 100150	CFP CFU CVP CVU CFJ CVJ 150150	

- Jaunās paaudzes virsgaismas logs
- Virsgaismas logs ar kupolu
- Kupols

Gaismas tuneļi

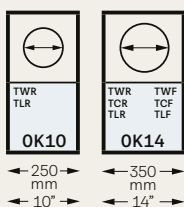

Saturs





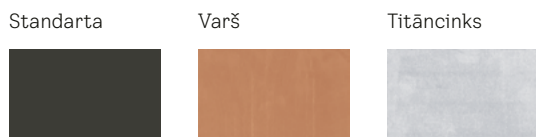







Stikla pakešu pārskats	4
Kombinētie pieslēgumi	6
Jumta logi	8
Jumta lūkas	18
Pieslēgumi iebūvēšanai slīpos jumtos	20
Produktu komplekti	44
Iebūvēšanas piederumi	48
Žalūzijas un slēgi	52
Elektriskie produkti	63
Produkti Velux jumta logu uzturēšanai un uzlabošanai	64
Gaismas tuneļi	66
Aksesuāri	67
Virsgaismas logi	68

Visas VELUX jumta logu uzlikas ir standarta pelēkā krāsā. Dažiem produktiem ir iespējams izvēlēties vara vai titāncinka uzlikas. Produktu veidi un cenu indeksi ir redzami tabulā. Lai iegūtu vairāk informācijas, lūdzu sazināties ar VELUX klientu servisu.



Ārējās uzlikas	Veids	Cenas indekss
Premium jumta logi		
Varš	GGL, GGU, GPL, GPU, GDL, GEL, VEA, VEB, VEC	170
Titāncinks	GGL, GGU, GPL, GPU, GDL, GEL, VEA, VEB, VEC	170
Pieslēgumi		
Varš	Paredzēts viena vai vairāku logu kombinētai iebūvēšanai	200
Titāncinks	Paredzēts viena vai vairāku logu kombinētai iebūvēšanai	160

Stikla pakešu pārskats

		Standard	Standard Plus
Stiklojums	51 	61 	64 
	VIENKAMERAS STIKLA PAKETE	ENERGOEFEKTIVITĀTE	ENERGO-EFEKTIVITĀTE UN KOMFORTS
 Divkameru stikla pakete		✓	✓
 Aizsardzība pret aukstumu		✓	✓
 Skaņas izolācija		✓	✓
 Lietus trokšņa samazināšana			✓
 Laminēts stikls drošībai			
 Rūdīts stikls	✓	✓	✓
 UV filtrs			
 Pārklājums vieglākai tīrīšanai			✓
 Pretnorošanas pārklājums			
U_w Siltumizolācija (viss logs) (W/m ² K)	1,3	1,1	1,0
U_g Siltumizolācija stiklam (W/m ² K)	1,0	0,6	0,6
g Kopējā saules enerģijas caurlaidība (%)	0,46	0,50	0,46
R_w Skaņas izolācija (dB)	31	32	35
Gaisa caurlaidības klase	3	4	4
Gāze stikla paketes kamerā	Argons	Argons	Argons
T_v Gaismas caurlaidība	0,69	0,68	0,62
T_{uv} UV caurlaidība	0,22	0,22	0,16
Aizsardzība pret ielaušanos	-	-	-
Drošības klase	-	-	-
Stikla paketes uzbūve	4 mm stikls 16 mm Argons 4 mm rūdīts stikls	4 mm stikls 15 mm Argons 3 mm augstā temp. apstrādāts stikls 15 mm Argons 3 mm rūdīts stikls	6 mm stikls 13 mm Argons 3 mm augstā temp. apstrādāts stikls 13 mm Argons 4 mm rūdīts stikls

* VELUX GGLS trīs vienā, GDL, GEL/VEA/VEB/VEC: lai saņemtu vairāk informācijas par tehniskajiem parametriem, lūdz sazināties ar klientu servisu.

** GGL/GGU: U_w = 0,92, GGL/GGU ar tāl vadību/GPU: U_w = 0,96, GIL/GIU/VFE/VIU: U_w = 1,0 (W/m²K)

Priekšrocības



Aizsardzība pret aukstumu

Patīkama iekštelpu temperatūra jebkādos laikapstākļos. Jo mazāka ir U vērtība, jo labāk.



Skaņas izolācija

Jo mazāk trokšņa no ārpuses, jo vairāk miera un komforta mājās. Jo augstāka ir R_w vērtība, jo labāk.



Lietus trokšņa samazināšana

Netraucēts miegs bez lietus trokšņa aiz loga.



Laminēts stikls drošībai

Novērš saplīsuša stikla iekrišanu telpā.

70	68	66	62	82
DROŠĪBA UN LIETUS TROKŠŅA SAMAZINĀŠANA	ENERGO-EFEKTIVITĀTE UN DROŠĪBA	ENERGO-EFEKTIVITĀTE UN SKAIDRS SKATS	ENERGO-EFEKTIVITĀTE UN SKAŅAS IZOLĀCIJA	PASĪVĀ MĀJA
	✓	✓	✓	✓
✓	✓	✓	✓	✓
✓	✓	✓	✓	✓
✓	✓	✓	✓	✓
✓	✓	✓	✓	✓
✓	✓	✓	✓	✓
✓	✓	✓	✓	✓
		✓		✓
		✓	✓	✓
1,3	1,1	1,0	0,92**	0,51
1,0	0,7	0,6	0,5	0,3
0,46	0,49	0,44	0,47	0,34
35	35	37	42	37
4	4	4	4	tbc
Argons	Argons	Argons	Kriptons	Kriptons
0,68	0,68	0,62	0,68	0,48
0,05	0,05	0,05	0,05	0,05
P2A	P2A	P2A	P2A	P2A
1B1	1B1	1B1	1B1	1B1
6.8 mm laminēts stikls 16 mm Argons 4 mm rūdīts stikls	6.8 mm laminēts stikls 13 mm Argons 3 mm augstā temp. apstrādāts stikls 13 mm Argons 4 mm rūdīts stikls	6.8 mm laminēts stikls 13 mm Argons 3 mm augstā temp. apstrādāts stikls 13 mm Argons 4 mm rūdīts stikls	6.8 mm laminēts stikls 11 mm Kriptons 3 mm augstā temp. apstrādāts stikls 11 mm Kriptons 8 mm rūdīts stikls	Iekšējā stikla pakete: 6.8 mm laminēts stikls 12 mm Kriptons 3 mm augstā temp. apstrādāts stikls 77.6 mm gaisa Ārējā stikla pakete: 3 mm augstā temp. apstrādāts stikls 14 mm Kriptons 3 mm augstā temp. apstrādāts stikls 14 mm Kriptons 4 mm rūdīts stikls



Rūdīts stikls

Piešķir stiprību ārējai rūtij, lai pasargātu no ekstremāliem laikapstākļiem, piemēram, spēcīgas vētras vai krusas.



UV filtrs

Aizsargā interjera mēbeles no izbalēšanas saules ietekmē un kaitīgajiem UV stariem.



Pašattīrošais pārklājums

Netīrumus atgrūdošs pārklājums ļauj veikt mazāk laika tīrīšanai un vairāk laika atpūtai.



Pretnorošanas pārklājums

Hidrofobs pārklājums samazina rasas daudzumu, kas var veidoties loga ārpusē, lai iegūtu skaidrāku skatu.

Kombinētie pieslēgumi

Pieslēgumi paredzēti jumta logu iebūvēšanai blokos dažādās kombinācijās.

Jumta logus GZL, GZL B, GLL, GLL B, GLU, GPL, GPU, GGL, GGU, GTL, GXL var iebūvēt jumtā neierobežotā skaitā.

- VELUX uzņemas atbildību par iebūvēšanas piederumu kvalitāti un nosaka jaunu produkta standartu jumta logu kombinācijām.
- Jaunā platumā pielāgojamā savienojošā detaļa vienkāršo iebūvēšanu, izslēdzot nepareiza izmēra detaļas pasūtīšanas risku un samazinot vajadzību pēc laiktīpiem mērījumiem.
- VELUX platumā pielāgojamā savienojošā detaļa iekļauta

standarta iebūvēšanas līmeņa komplektos EKW, EKS, EKL, EKE. Standarta rāmja attālums „a” starp elementiem var būt 10–16 cm.

- Fiksēto savienojošo detaļu veidi iekļauti EKT un EKB komplektos. Standarta rāmja attālums „a” starp elementiem var būt E=10cm, F=12cm, G=14cm, H=16cm
Viens blakus otram un viens virs otra risinājumiem pēdējais cipars kodā nozīmē elementa atrašanās vietu jumtā.

Jumta logi viens blakus otram

Divi logi viens blakus otram

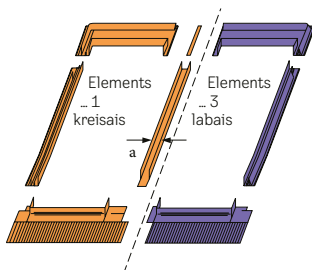

Jumta logi viens virs otra

Divi logi viens virs otra

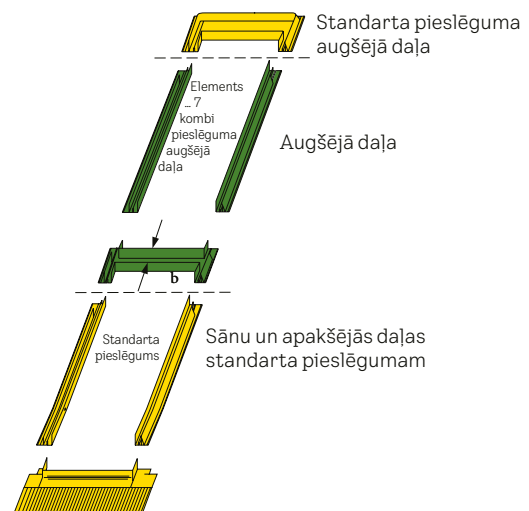

Trīs logi viens blakus otram

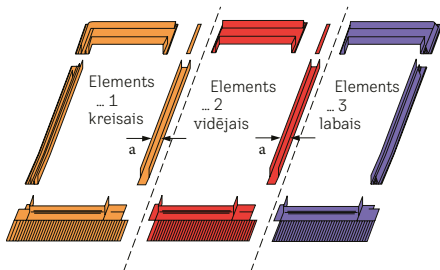

Trīs logi viens virs otra

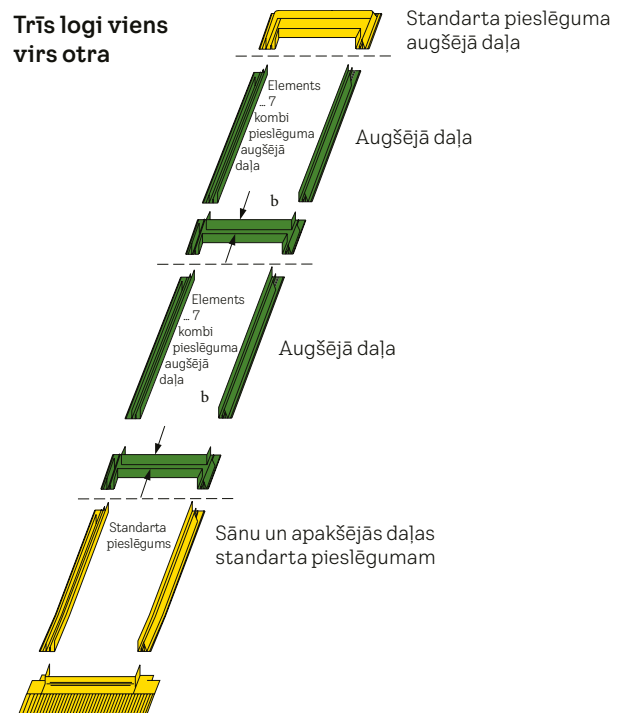

Četri logi viens blakus otram

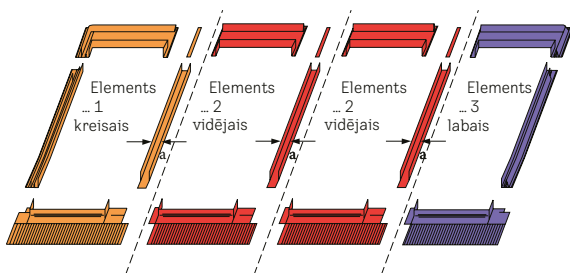

Logi blakus un viens virs otra

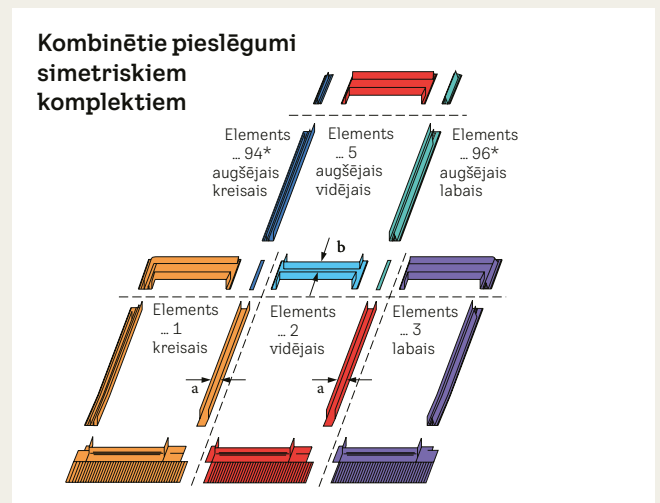
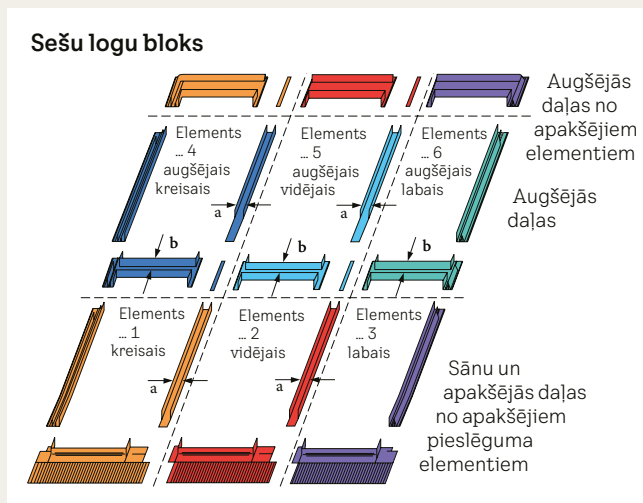
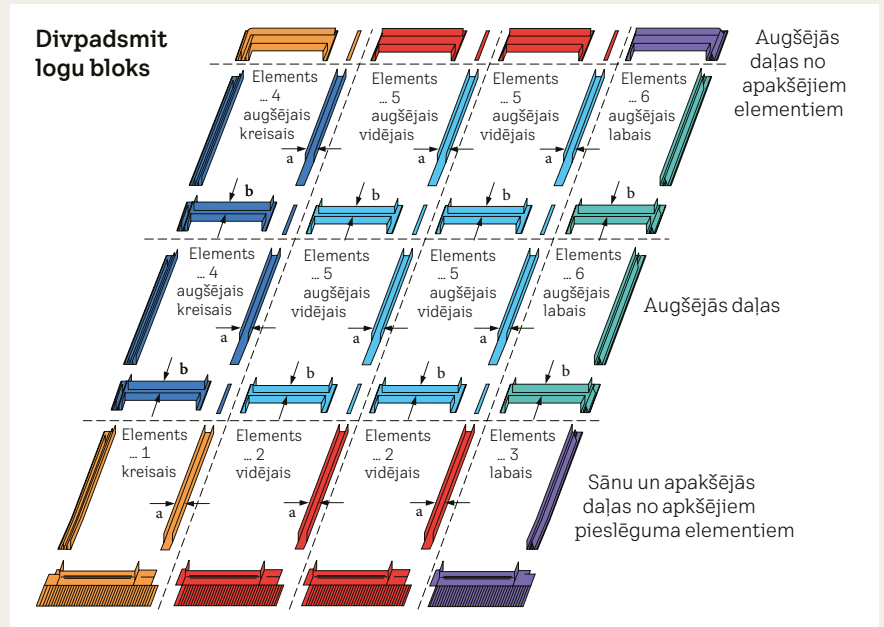
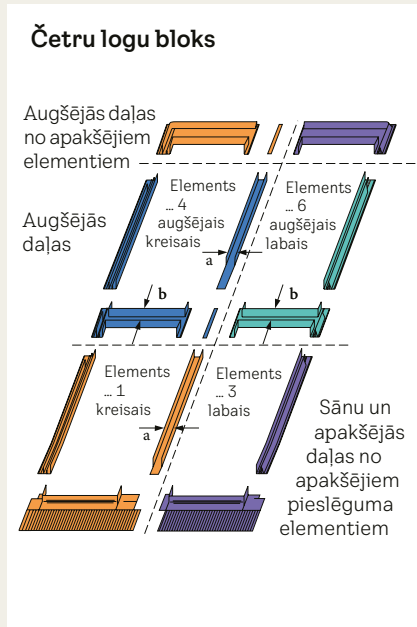

*94. un 96. elements ir pieejami pasūtīšanai tikai kā speciālie materiāli.

Padomi

- Elementu novietojums vienmēr tiek noteikts no ārpuses.
- Visiem logiem, kas atrodas blakus, ir jābūt vienādā garumā.
- Visiem logiem, kas atrodas viens virs otra, jābūt vienādā platumā.
- Jaunā platumā pielāgojamā savienojošā detaļa piemērota logu attālumam no 10 līdz 16 cm.

Loga platums cm (izmērs)	55 (C--)	66 (F--)	78 (M--)	94 (P--)	114 (S--)	134 (U--)
Ieteicamais attālums starp spārēm (cm) logam ar BDX komplektu	59-61	70-72	82-84	98-100	118-120	138-140

Cenas

JUMTA LOGI SLĪPAJIEM JUMTIEM



Cenas bez PVN, Eiro
Cenas ar PVN, Eiro



CK02
55x78



CK04
55x98



FK04
66x98



FK06
66x118



FK08
66x140



MK04
78x98



MK06
78x118



MK08
78x140

STANDARD, ROKTURIS VĒRTNES AUGŠĀ VAI APAKŠĀ

		W/(m ² K) Iebūvēšanas slīpums										
GZL 1051	Verams ar roku, rokturis augšā, priedes koks, apstrādāts ar dubultu pārklājumu, caurspīdīgs lakojušs, vienkameras stikla pakete	1.3	15-90	228,93 277,00	243,80 295,00	271,07 328,00	282,64 342,00	309,92 375,00	276,86 335,00	300,83 364,00	321,49 389,00	
GZL 1051B	Verams ar roku, rokturis apakšā, priedes koks, apstrādāts ar dubultu pārklājumu, caurspīdīgs lakojušs, vienkameras stikla pakete	1.3	15-90	-	-	-	282,64 342,00	-	276,86 335,00	300,83 364,00	321,49 389,00	
GLU 0051	Verams ar roku, rokturis augšā, balts poliuretāns ap koka kodolu ar papildu izturīgu pārklājumu, vienkameras stikla pakete	1.3	15-90	285,95 346,00	-	-	353,72 428,00	387,60 469,00	346,28 419,00	376,03 455,00	402,48 487,00	
GLU 0051B	Verams ar roku, rokturis apakšā, balts poliuretāns ap koka kodolu ar papildu izturīgu pārklājumu, vienkameras stikla pakete	1.3	15-90	-	-	-	353,72 428,00	-	346,28 419,00	376,03 455,00	402,48 487,00	



Cenas bez PVN, Eiro
Cenas ar PVN, Eiro



CK02
55x78



CK04
55x98



FK04
66x98



FK06
66x118



FK08
66x140



MK04
78x98



MK06
78x118



MK08
78x140

STANDARD, ROKTURIS VĒRTNES AUGŠĀ VAI APAKŠĀ

		W/(m ² K) Iebūvēšanas slīpums										
GLL 1061	Verams ar roku, rokturis augšā, priedes koks, apstrādāts ar dubultu pārklājumu, caurspīdīgs lakojušs, divkameru stikla pakete	1.1	15-90	285,95 346,00	304,96 369,00	338,84 410,00	353,72 428,00	387,60 469,00	346,28 419,00	376,03 455,00	402,48 487,00	
GLL 1061B	Verams ar roku, rokturis apakšā, priedes koks, apstrādāts ar dubultu pārklājumu, caurspīdīgs lakojušs, divkameru stikla pakete	1.1	15-90	-	304,96 369,00	-	353,72 428,00	387,60 469,00	346,28 419,00	376,03 455,00	402,48 487,00	
GLU 0061	Verams ar roku, rokturis augšā, balts poliuretāns ap koka kodolu ar papildu izturīgu pārklājumu, divkameru stikla pakete	1.1	15-90	357,02 432,00	380,99 461,00	-	442,15 535,00	484,30 586,00	432,23 523,00	470,25 569,00	503,31 609,00	
GLU 0061B	Verams ar roku, rokturis apakšā, balts poliuretāns ap koka kodolu ar papildu izturīgu pārklājumu, divkameru stikla pakete	1.1	15-90	-	380,99 461,00	-	442,15 535,00	484,30 586,00	432,23 523,00	470,25 569,00	503,31 609,00	

	MK10 78x160	PK06 94x118	PK08 94x140	SK06 114x118	SK08 114x140
	372,73 451,00	352,07 426,00	376,03 455,00	370,25 448,00	412,40 499,00
	372,73 451,00	352,07 426,00	376,03 455,00	-	-
	466,12 564,00	-	-	-	514,88 623,00
	-	-	470,25 569,00	-	-

	MK10 78x160	PK06 94x118	PK08 94x140	SK06 114x118	SK08 114x140
	466,12 564,00	439,67 532,00	470,25 569,00	462,81 560,00	514,88 623,00
	466,12 564,00	-	470,25 569,00	-	-
	582,64 705,00	-	587,60 711,00	-	643,80 779,00
	582,64 705,00	-	587,60 711,00	-	-

Jumta loga rāmja izmērs, cm	Senāka loga kods			Jaunākās paaudzes loga kods
	Ražots līdz 1992. gadam	Ražots līdz 2003. gadam	Ražots līdz 2014. gadam	Pieejams šobrīd
55 × 78	-	102	C02	CK02
55 × 98	6	104	C04	CK04
66 × 98	-	204	F04	FK04
66 × 118	-	206	F06	FK06
66 × 140	-	-	F08	FK08
70 × 118	5	-	-	FK06*
78 × 98	1	304	M04	MK04
78 × 118	14	306	M06	MK06
78 × 140	12	308	M08	MK08
78 × 160	13	310	M10	MK10
94 × 98	-	404	P04	PK04
94 × 118	-	406	P06	PK06
94 × 140	-	408	P08	PK08
94 × 160	13	410	P10	PK10
114 × 118	14	606	S06	SK06
114 × 140	10	608	S08	SK08
114 × 160	-	610	S10	SK10
134 × 98	-	804	U04	UK04
134 × 140	8	808	U08	UK08
134 × 160	-	810	U10	UK10

* FK06 izmēra jumta logi ir 4 cm šaurāki nekā senākie jumta logi, kas ražoti līdz 1992. gadam.



Cenas bez PVN, Euro
Cenas ar PVN, Euro



CK02 55x78	FK06 66x118	MK04 78x98	MK06 78x118	MK08 78x140	MK10 78x160	PK08 94x140	

STANDARD ELEKTRISKIE/SOLĀRIE JUMTA LOGI AR TĀLVADĪBU

		W/(m ² K) Iebūvēšanas slīpums									
GLL 106121	Elektrisks, priedes koks, apstrādāts ar dubultu pārklājumu, caurspīdīgs lakojušs, divkameru stikla pakete	1.1	15-90	657,85 796,00	725,62 878,00	718,18 869,00	747,93 905,00	774,38 937,00	838,02 1 014,00	842,15 1 019,00	
GLL 106130	Solārs, priedes koks, apstrādāts ar dubultu pārklājumu, caurspīdīgs lakojušs, divkameru stikla pakete	1.1	15-90	657,85 796,00	725,62 878,00	718,18 869,00	747,93 905,00	774,38 937,00	838,02 1 014,00	842,15 1 019,00	
GLU 006121	Elektrisks, balts poliuretāns ap koka kodolu ar papildu izturīgu pārklājumu, divkameru stikla pakete	1.1	15-90	728,93 882,00	814,05 985,00	804,13 973,00	842,15 1 019,00	875,21 1 059,00	954,55 1 155,00	959,50 1 161,00	
GLU 006130	Solārs, balts poliuretāns ap koka kodolu ar papildu izturīgu pārklājumu, divkameru stikla pakete	1.1	15-90	728,93 882,00	814,05 985,00	804,13 973,00	842,15 1 019,00	875,21 1 059,00	954,55 1 155,00	959,50 1 161,00	



Cenas bez PVN, Euro
Cenas ar PVN, Euro

CK02 55x78	CK04 55x98	FK04 66x98	FK06 66x118	FK08 66x140	MK04 78x98	MK06 78x118	MK08 78x140	

STANDARD PLUS, ROKTURIS VĒRTNES AUGŠĀ VAI APAKŠĀ

		W/(m ² K) Iebūvēšanas slīpums										
GLL 1064	Verams ar roku, rokturis augšā, priedes koks, apstrādāts ar dubultu pārklājumu, caurspīdīgs lakojušs, divkameru stikla pakete	1.0	15-90	357,02 432,00	380,99 461,00	423,14 512,00	442,15 535,00	484,30 586,00	432,23 523,00	470,25 569,00	503,31 609,00	
GLL 1064B	Verams ar roku, rokturis apakšā, priedes koks, apstrādāts ar dubultu pārklājumu, caurspīdīgs lakojušs, divkameru stikla pakete	1.0	15-90	-	380,99 461,00	-	442,15 535,00	484,30 586,00	432,23 523,00	470,25 569,00	503,31 609,00	
GLU 0064	Verams ar roku, rokturis augšā, balts poliuretāns ap koka kodolu ar papildu izturīgu pārklājumu, divkameru stikla pakete	1.0	15-90	445,45 539,00	475,21 575,00	-	551,24 667,00	604,13 731,00	539,67 653,00	586,78 710,00	627,27 759,00	
GLU 0064B	Verams ar roku, rokturis apakšā, balts poliuretāns ap koka kodolu ar papildu izturīgu pārklājumu, divkameru stikla pakete	1.0	15-90	-	475,21 575,00	-	551,24 667,00	604,13 731,00	539,67 653,00	586,78 710,00	627,27 759,00	

	 MK10 78x160	 PK06 94x118	 PK08 94x140	 SK06 114x118	 SK08 114x140
	582,64 705,00	549,59 665,00	587,60 711,00	578,51 700,00	643,80 779,00
	582,64 705,00	-	587,60 711,00	-	-
	727,27 880,00	-	733,06 887,00	-	803,31 972,00
	727,27 880,00	-	733,06 887,00	-	-



Cenas bez PVN, Eiro
Cenas ar PVN, Eiro



CK02
55x78



CK04
55x98



CK06
55x118



FK04
66x98



FK06
66x118



FK08
66x140



MK04
78x98















MK06
78x118

PREMIUM, ROKTURIS VĒRTNES AUGŠĀ

W/(m² K) Iebūvēšanas
slīpums

GGL 3070	Verams ar roku, rokturis augšā, priedes koks, apstrādāts ar trīskāršu pārklājumu, caurspīdīgs lakojums, vienkameras stikla pakete	1.3	15-90	309,92 375,00	330,58 400,00	367,77 445,00	367,77 445,00	383,47 464,00	420,66 509,00	375,21 454,00	408,26 494,00
GGL 3070Q	Verams ar roku, rokturis augšā, priedes koks, apstrādāts ar trīskāršu pārklājumu, caurspīdīgs lakojums, vienkameras stikla pakete	1.3	15-90	403,31 488,00	429,75 520,00	-	-	499,17 604,00	-	488,43 591,00	530,58 642,00
GGL 3068	Verams ar roku, rokturis augšā, priedes koks, apstrādāts ar trīskāršu pārklājumu, caurspīdīgs lakojums, divkameru stikla pakete	1.1	15-90	387,60 469,00	413,22 500,00	459,50 556,00	459,50 556,00	479,34 580,00	525,62 636,00	469,42 568,00	510,74 618,00
GGL 3066	Verams ar roku, rokturis augšā, priedes koks, apstrādāts ar trīskāršu pārklājumu, caurspīdīgs lakojums, divkameru stikla pakete	1.0	15-90	434,71 526,00	462,81 560,00	514,05 622,00	514,05 622,00	537,19 650,00	588,43 712,00	525,62 636,00	571,90 692,00
GGL 3062	Verams ar roku, rokturis augšā, priedes koks, apstrādāts ar trīskāršu pārklājumu, caurspīdīgs lakojums, divkameru stikla pakete	0.92	15-90	539,67 653,00	575,21 696,00	639,67 774,00	639,67 774,00	667,77 808,00	731,40 885,00	653,72 791,00	710,74 860,00
GGU 0070	Verams ar roku, rokturis augšā, balts poliuretāns ap koka kodolu ar papildu izturīgu pārklājumu, vienkameras stikla pakete	1.3	15-90	387,60 469,00	413,22 500,00	459,50 556,00	459,50 556,00	479,34 580,00	525,62 636,00	469,42 568,00	510,74 618,00
GGU 0068	Verams ar roku, rokturis augšā, balts poliuretāns ap koka kodolu ar papildu izturīgu pārklājumu, divkameru stikla pakete	1.1	15-90	485,12 587,00	516,53 625,00	574,38 695,00	574,38 695,00	600,00 726,00	657,02 795,00	586,78 710,00	638,02 772,00
GGU 0066	Verams ar roku, rokturis augšā, balts poliuretāns ap koka kodolu ar papildu izturīgu pārklājumu, divkameru stikla pakete	1.0	15-90	542,98 657,00	578,51 700,00	642,98 778,00	642,98 778,00	671,90 813,00	735,54 890,00	657,02 795,00	714,88 865,00
GGU 0062	Verams ar roku, rokturis augšā, balts poliuretāns ap koka kodolu ar papildu izturīgu pārklājumu, divkameru stikla pakete	0.92	15-90	675,21 817,00	719,01 870,00	799,17 967,00	799,17 967,00	834,71 1 010,00	914,88 1 107,00	816,53 988,00	887,60 1 074,00
GGU 0070Q	Verams ar roku, rokturis augšā, balts poliuretāns ap koka kodolu ar papildu izturīgu pārklājumu, vienkameras stikla pakete	1.3	15-90	504,13 610,00	537,19 650,00	-	596,69 722,00	623,97 755,00	-	610,74 739,00	663,64 803,00
GGL 2070	Verams ar roku, rokturis augšā, priedes koks, apstrādāts ar trīskāršu pārklājumu, balti krāsots, vienkameras stikla pakete	1.3	15-90	309,92 375,00	330,58 400,00	367,77 445,00	367,77 445,00	383,47 464,00	420,66 509,00	375,21 454,00	408,26 494,00
GGL 2070Q	Verams ar roku, rokturis augšā, priedes koks, apstrādāts ar trīskāršu pārklājumu, balti krāsots, vienkameras stikla pakete	1.3	15-90	403,31 488,00	429,75 520,00	-	477,69 578,00	499,17 604,00	-	488,43 591,00	530,58 642,00
GGL 2068	Verams ar roku, rokturis augšā, priedes koks, apstrādāts ar trīskāršu pārklājumu, balti krāsots, divkameru stikla pakete	1.1	15-90	387,60 469,00	413,22 500,00	459,50 556,00	459,50 556,00	479,34 580,00	525,62 636,00	469,42 568,00	510,74 618,00
GGL 2066	Verams ar roku, rokturis augšā, priedes koks, apstrādāts ar trīskāršu pārklājumu, balti krāsots, divkameru stikla pakete	1.0	15-90	434,71 526,00	462,81 560,00	514,05 622,00	514,05 622,00	537,19 650,00	588,43 712,00	525,62 636,00	571,90 692,00
GGL 2062	Verams ar roku, rokturis augšā, priedes koks, apstrādāts ar trīskāršu pārklājumu, balti krāsots, divkameru stikla pakete	0.92	15-90	539,67 653,00	575,21 696,00	639,67 774,00	639,67 774,00	667,77 808,00	731,40 885,00	653,72 791,00	710,74 860,00

											
MK08 78x140	MK10 78x160	MK12 78x180	PK06 94x118	PK08 94x140	PK10 94x160	SK06 114x118	SK08 114x140	SK10 114x160	UK04 134x98	UK08 134x140	UK10 134x160

437,19 529,00	506,61 613,00	576,03 697,00	477,69 578,00	510,74 618,00	551,24 667,00	502,48 608,00	559,50 677,00	620,66 751,00	514,05 622,00	624,79 756,00	702,48 850,00
567,77 687,00	657,85 796,00	-	620,66 751,00	663,64 803,00	716,53 867,00	652,89 790,00	727,27 880,00	806,61 976,00	668,60 809,00	812,40 983,00	913,22 1 105,00
546,28 661,00	633,06 766,00	719,83 871,00	596,69 722,00	638,02 772,00	689,26 834,00	628,10 760,00	699,17 846,00	776,03 939,00	642,98 778,00	780,99 945,00	877,69 1 062,00
611,57 740,00	709,09 858,00	805,79 975,00	668,60 809,00	714,88 865,00	771,90 934,00	703,31 851,00	782,64 947,00	868,60 1 051,00	719,83 871,00	874,38 1 058,00	983,47 1 190,00
760,33 920,00	880,99 1 066,00	-	831,40 1 006,00	887,60 1 074,00	958,68 1 160,00	873,55 1 057,00	973,55 1 178,00	-	-	-	-
546,28 661,00	633,06 766,00	-	596,69 722,00	638,02 772,00	689,26 834,00	628,10 760,00	699,17 846,00	776,03 939,00	642,98 778,00	780,99 945,00	877,69 1 062,00
682,64 826,00	790,91 957,00	-	746,28 903,00	797,52 965,00	861,16 1 042,00	784,30 949,00	873,55 1 057,00	969,42 1 173,00	804,13 973,00	976,03 1 181,00	1 097,52 1 328,00
764,46 925,00	885,95 1 072,00	-	835,54 1 011,00	893,39 1 081,00	964,46 1 167,00	878,51 1 063,00	978,51 1 184,00	1 085,95 1 314,00	900,00 1 089,00	1 093,39 1 323,00	1 228,93 1 487,00
950,41 1 150,00	1 100,83 1 332,00	-	1 038,84 1 257,00	1 109,92 1 343,00	1 199,17 1 451,00	1 092,56 1 322,00	1 216,53 1 472,00	-	-	-	-
709,92 859,00	822,31 995,00	-	776,03 939,00	828,93 1 003,00	895,87 1 084,00	815,70 987,00	909,09 1 100,00	-	835,54 1 011,00	1 014,88 1 228,00	-
437,19 529,00	506,61 613,00	576,03 697,00	477,69 578,00	510,74 618,00	551,24 667,00	502,48 608,00	559,50 677,00	620,66 751,00	514,05 622,00	624,79 756,00	702,48 850,00
567,77 687,00	657,85 796,00	-	620,66 751,00	663,64 803,00	716,53 867,00	652,89 790,00	727,27 880,00	806,61 976,00	668,60 809,00	812,40 983,00	913,22 1 105,00
546,28 661,00	633,06 766,00	719,83 871,00	596,69 722,00	638,02 772,00	689,26 834,00	628,10 760,00	699,17 846,00	776,03 939,00	642,98 778,00	780,99 945,00	877,69 1 062,00
611,57 740,00	709,09 858,00	805,79 975,00	668,60 809,00	714,88 865,00	771,90 934,00	703,31 851,00	782,64 947,00	868,60 1 051,00	719,83 871,00	874,38 1 058,00	983,47 1 190,00
760,33 920,00	880,99 1 066,00	-	831,40 1 006,00	887,60 1 074,00	958,68 1 160,00	873,55 1 057,00	973,55 1 178,00	-	-	-	-





Cenas bez PVN, Euro
Cenas ar PVN, Euro

CK04 55x98	CK06 55x118	FK06 66x118	FK08 66x140	MK04 78x98	MK06 78x118	MK08 78x140	MK10 78x160		

PREMIUM, ROKTURIS VĒRTNES AUGŠĀ UN APAKŠĀ

		W/(m² K) Iebūvēšanas slīpums											
GPL 3070	Verams ar roku, rokturis apakšā, pa augšējo asi verams, priedes koks, apstrādāts ar trīskāršu pārklājumu, caurspīdīgs lakojujums, vienkameras stikla pakete	1.3	15-55	530,58 642,00	567,77 687,00	583,47 706,00	620,66 751,00	575,21 696,00	608,26 736,00	637,19 771,00	706,61 855,00		
GPL 3068	Verams ar roku, rokturis apakšā, pa augšējo asi verams, priedes koks, apstrādāts ar trīskāršu pārklājumu, caurspīdīgs lakojujums, divkameru stikla pakete	1.1	15-55	613,22 742,00	659,50 798,00	679,34 822,00	725,62 878,00	669,42 810,00	710,74 860,00	746,28 903,00	833,06 1 008,00		
GPL 3066	Verams ar roku, rokturis apakšā, pa augšējo asi verams, priedes koks, apstrādāts ar trīskāršu pārklājumu, caurspīdīgs lakojujums, divkameru stikla pakete	1.0	15-55	662,81 802,00	714,05 864,00	737,19 892,00	788,43 954,00	725,62 878,00	771,90 934,00	811,57 982,00	909,09 1 100,00		
GPU 0070	Verams ar roku, rokturis apakšā, pa augšējo asi verams, balts poliuretāns ap koka kodolu ar papildu izturīgu pārklājumu, vienkameras stikla pakete	1.3	15-55	613,22 742,00	659,50 798,00	679,34 822,00	725,62 878,00	669,42 810,00	710,74 860,00	746,28 903,00	833,06 1 008,00		
GPU 0068	Verams ar roku, rokturis apakšā, pa augšējo asi verams, balts poliuretāns ap koka kodolu ar papildu izturīgu pārklājumu, divkameru stikla pakete	1.1	15-55	716,53 867,00	774,38 937,00	800,00 968,00	857,02 1 037,00	786,78 952,00	838,02 1 014,00	882,64 1 068,00	990,91 1 199,00		
GPU 0066	Verams ar roku, rokturis apakšā, pa augšējo asi verams, balts poliuretāns ap koka kodolu ar papildu izturīgu pārklājumu, divkameru stikla pakete	1.0	15-55	778,51 942,00	842,98 1 020,00	871,90 1 055,00	935,54 1 132,00	857,02 1 037,00	914,88 1 107,00	964,46 1 167,00	1 085,95 1 314,00		
GPU 0062	Verams ar roku, rokturis apakšā, pa augšējo asi verams, balts poliuretāns ap koka kodolu ar papildu izturīgu pārklājumu, divkameru stikla pakete	0.96	15-55	919,01 1 112,00	999,17 1 209,00	1 034,71 1 252,00	1 114,88 1 349,00	1 016,53 1 230,00	1 087,60 1 316,00	1 150,41 1 392,00	1 300,83 1 574,00		
GPL 2070	Verams ar roku, rokturis apakšā, pa augšējo asi verams, priedes koks, apstrādāts ar trīskāršu pārklājumu, balti krāsots, vienkameras stikla pakete	1.3	15-55	530,58 642,00	567,77 687,00	583,47 706,00	620,66 751,00	575,21 696,00	608,26 736,00	637,19 771,00	706,61 855,00		
GPL 2068	Verams ar roku, rokturis apakšā, pa augšējo asi verams, priedes koks, apstrādāts ar trīskāršu pārklājumu, balti krāsots, divkameru stikla pakete	1.1	15-55	613,22 742,00	659,50 798,00	679,34 822,00	725,62 878,00	669,42 810,00	710,74 860,00	746,28 903,00	833,06 1 008,00		
GPL 2066	Verams ar roku, rokturis apakšā, pa augšējo asi verams, priedes koks, apstrādāts ar trīskāršu pārklājumu, balti krāsots, divkameru stikla pakete	1.0	15-55	662,81 802,00	714,05 864,00	737,19 892,00	788,43 954,00	725,62 878,00	771,90 934,00	811,57 982,00	909,09 1 100,00		

Pa augšējo asi veramie jumta logi ir aprīkoti arī ar eņģi pa vidu, kas atvieglo loga vērtnes pagriešanu tīrīšanai.

	 PK06 94x118	 PK08 94x140	 PK10 94x160	 SK06 114x118	 SK08 114x140	 SK10 114x160	 UK04 134x98	 UK08 134x140
	677,69 820,00	710,74 860,00	751,24 909,00	702,48 850,00	759,50 919,00	820,66 993,00	714,05 864,00	824,79 998,00
	796,69 964,00	838,02 1 014,00	889,26 1 076,00	828,10 1 002,00	899,17 1 088,00	976,03 1 181,00	842,98 1 020,00	980,99 1 187,00
	868,60 1 051,00	914,88 1 107,00	971,90 1 176,00	903,31 1 093,00	982,64 1 189,00	1 068,60 1 293,00	919,83 1 113,00	1 074,38 1 300,00
	796,69 964,00	838,02 1 014,00	889,26 1 076,00	828,10 1 002,00	899,17 1 088,00	976,03 1 181,00	-	980,99 1 187,00
	946,28 1 145,00	997,52 1 207,00	1 061,16 1 284,00	984,30 1 191,00	1 073,55 1 299,00	1 169,42 1 415,00	-	1 176,03 1 423,00
	1 035,54 1 253,00	1 093,39 1 323,00	1 164,46 1 409,00	1 078,51 1 305,00	1 178,51 1 426,00	1 285,95 1 556,00	-	1 293,39 1 565,00
	1 238,84 1 499,00	1 309,92 1 585,00	1 399,17 1 693,00	1 292,56 1 564,00	1 416,53 1 714,00	-	-	-
	677,69 820,00	710,74 860,00	751,24 909,00	702,48 850,00	759,50 919,00	820,66 993,00	714,05 864,00	824,79 998,00
	796,69 964,00	838,02 1 014,00	889,26 1 076,00	828,10 1 002,00	899,17 1 088,00	976,03 1 181,00	842,98 1 020,00	980,99 1 187,00
	868,60 1 051,00	914,88 1 107,00	971,90 1 176,00	903,31 1 093,00	982,64 1 189,00	1 068,60 1 293,00	919,83 1 113,00	1 074,38 1 300,00



Cenas bez PVN, Eiro
Cenas ar PVN, Eiro



CK02
55x78



CK04
55x98



CK06
55x118



FK04
66x98



FK06
66x118



FK08
66x140



MK04
78x98













MK06
78x118

JUMTA LOGI AR TĀLVADĪBU

W/(m² K) Iebūvēšanas
slīpums

GGL 307021	Elektrisks, priedes koks, apstrādāts ar trīskāršu pārklājumu, caurspīdīgs lakojušs, vienkameru stikla pakete	1.3	15-90	-	-	-	-	-	-	-	-	-
GGL 306821	Elektrisks, priedes koks, apstrādāts ar trīskāršu pārklājumu, caurspīdīgs lakojušs, divkameru stikla pakete	1.1	15-90	763,64 924,00	789,26 955,00	835,54 1 011,00	835,54 1 011,00	855,37 1 035,00	901,65 1 091,00	845,45 1 023,00	886,78 1 073,00	
GGL 306621	Elektrisks, priedes koks, apstrādāts ar trīskāršu pārklājumu, caurspīdīgs lakojušs, divkameru stikla pakete	1.0	15-90	810,74 981,00	838,84 1 015,00	890,08 1 077,00	890,08 1 077,00	913,22 1 105,00	964,46 1 167,00	901,65 1 091,00	947,93 1 147,00	
GGL 306221	Elektrisks, priedes koks, apstrādāts ar trīskāršu pārklājumu, caurspīdīgs lakojušs, divkameru stikla pakete	0.96	15-90	915,70 1 108,00	951,24 1 151,00	1 015,70 1 229,00	1 015,70 1 229,00	1 043,80 1 263,00	1 107,44 1 340,00	1 029,75 1 246,00	1 086,78 1 315,00	
GGL 306830	Solārs, priedes koks, apstrādāts ar trīskāršu pārklājumu, caurspīdīgs lakojušs, divkameru stikla pakete	1.1	15-90	763,64 924,00	789,26 955,00	835,54 1 011,00	-	855,37 1 035,00	901,65 1 091,00	845,45 1 023,00	886,78 1 073,00	
GGL 306630	Solārs, priedes koks, apstrādāts ar trīskāršu pārklājumu, caurspīdīgs lakojušs, divkameru stikla pakete	1.0	15-90	810,74 981,00	838,84 1 015,00	890,08 1 077,00	-	913,22 1 105,00	964,46 1 167,00	901,65 1 091,00	947,93 1 147,00	
GGU 006821	Elektrisks, balts poliuretāns ap koka kodolu ar papildu izturīgu pārklājumu, divkameru stikla pakete	1.1	15-90	861,16 1 042,00	892,56 1 080,00	950,41 1 150,00	950,41 1 150,00	976,03 1 181,00	1 033,06 1 250,00	962,81 1 165,00	1 014,05 1 227,00	
GGU 006621	Elektrisks, balts poliuretāns ap koka kodolu ar papildu izturīgu pārklājumu, divkameru stikla pakete	1.0	15-90	919,01 1 112,00	954,55 1 155,00	1 019,01 1 233,00	1 019,01 1 233,00	1 047,93 1 268,00	1 111,57 1 345,00	1 033,06 1 250,00	1 090,91 1 320,00	
GGU 006221	Elektrisks, balts poliuretāns ap koka kodolu ar papildu izturīgu pārklājumu, divkameru stikla pakete	0.96	15-90	1 051,24 1 272,00	1 095,04 1 325,00	1 175,21 1 422,00	1 175,21 1 422,00	1 210,74 1 465,00	1 290,91 1 562,00	1 192,56 1 443,00	1 263,64 1 529,00	
GGU 006830	Solārs, balts poliuretāns ap koka kodolu ar papildu izturīgu pārklājumu, divkameru stikla pakete	1.1	15-90	861,16 1 042,00	892,56 1 080,00	950,41 1 150,00	-	976,03 1 181,00	1 033,06 1 250,00	962,81 1 165,00	1 014,05 1 227,00	
GGU 006630	Solārs, balts poliuretāns ap koka kodolu ar papildu izturīgu pārklājumu, divkameru stikla pakete	1.0	15-90	919,01 1 112,00	954,55 1 155,00	1 019,01 1 233,00	-	1 047,93 1 268,00	1 111,57 1 345,00	1 033,06 1 250,00	1 090,91 1 320,00	
GPU 006621	Elektrisks, balts poliuretāns ap koka kodolu ar papildu izturīgu pārklājumu, divkameru stikla pakete	1.0	15-65	-	-	-	-	1 362,81 1 649,00	1 426,45 1 726,00	-	1 405,79 1 701,00	

 MK08 78x140	 MK10 78x160	 PK06 94x118	 PK08 94x140	 PK10 94x160	 SK06 114x118	 SK08 114x140	 SK10 114x160	 UK04 134x98	 UK08 134x140	 UK10 134x160
---	---	---	---	---	--	--	--	---	--	--

-	-	-	-	-	-	-	-	-	-	-
922,31 1 116,00	1 009,09 1 221,00	972,73 1 177,00	1 014,05 1 227,00	1 065,29 1 289,00	1 004,13 1 215,00	1 075,21 1 301,00	1 152,07 1 394,00	1 019,01 1 233,00	1 157,02 1 400,00	1 253,72 1 517,00
987,60 1 195,00	1 085,12 1 313,00	1 044,63 1 264,00	1 090,91 1 320,00	1 147,93 1 389,00	1 079,34 1 306,00	1 158,68 1 402,00	1 244,63 1 506,00	1 095,87 1 326,00	1 250,41 1 513,00	1 359,50 1 645,00
1 136,36 1 375,00	1 257,02 1 521,00	1 207,44 1 461,00	1 263,64 1 529,00	1 334,71 1 615,00	1 249,59 1 512,00	1 349,59 1 633,00	-	-	-	-
922,31 1 116,00	-	972,73 1 177,00	-	1 065,29 1 289,00	1 004,13 1 215,00	1 075,21 1 301,00	-	1 019,01 1 233,00	1 157,02 1 400,00	-
987,60 1 195,00	1 085,12 1 313,00	-	1 090,91 1 320,00	1 147,93 1 389,00	1 079,34 1 306,00	-	-	1 095,87 1 326,00	1 250,41 1 513,00	-
1 058,68 1 281,00	1 166,94 1 412,00	1 122,31 1 358,00	1 173,55 1 420,00	1 237,19 1 497,00	1 160,33 1 404,00	1 249,59 1 512,00	1 345,45 1 628,00	1 180,17 1 428,00	1 352,07 1 636,00	1 473,55 1 783,00
1 140,50 1 380,00	1 261,98 1 527,00	1 211,57 1 466,00	1 269,42 1 536,00	1 340,50 1 622,00	1 254,55 1 518,00	1 354,55 1 639,00	1 461,98 1 769,00	-	1 469,42 1 778,00	1 604,96 1 942,00
1 326,45 1 605,00	1 476,86 1 787,00	1 414,88 1 712,00	1 485,95 1 798,00	1 575,21 1 906,00	1 468,60 1 777,00	1 592,56 1 927,00	-	-	-	-
1 058,68 1 281,00	-	1 122,31 1 358,00	-	1 237,19 1 497,00	1 160,33 1 404,00	1 249,59 1 512,00	1 345,45 1 628,00	1 180,17 1 428,00	1 352,07 1 636,00	1 473,55 1 783,00
1 140,50 1 380,00	1 261,98 1 527,00	1 211,57 1 466,00	1 269,42 1 536,00	1 340,50 1 622,00	1 254,55 1 518,00	-	1 461,98 1 769,00	1 276,03 1 544,00	1 469,42 1 778,00	1 604,96 1 942,00
1 455,37 1 761,00	-	1 526,45 1 847,00	1 584,30 1 917,00	-	1 569,42 1 899,00	1 669,42 2 020,00	-	-	-	-

JUMTA LŪKAS



Cenas bez PVN, Eiro
Cenas ar PVN, Eiro

CK06
55x118

FK06
66x118

MK04
78x98

JUMTA LŪKAS

		W/(m ² K)		Iebūvēšanas slīpums			
GXL 3070	Manuāla, priedes koks, apstrādāts ar trīskāršu pārklājumu, caurspīdīgs lakojums, vienkameras stikla pakete	1.3	15-85	-	499,17 604,00	488,43 591,00	
GXL 3068	Manuāla, priedes koks, apstrādāts ar trīskāršu pārklājumu, caurspīdīgs lakojums, divkameru stikla pakete	1.1	15-85	-	623,97 755,00	-	
GXL 3066	Manuāla, priedes koks, apstrādāts ar trīskāršu pārklājumu, caurspīdīgs lakojums, divkameru stikla pakete	1.0	15-85	-	698,35 845,00	-	
GXU 0070	Manuāla, balts poliuretāns ap koka kodolu ar papildu izturīgu pārklājumu, vienkameras stikla pakete	1.3	15-85	543,80 658,00	567,77 687,00	-	
GXU 0066	Manuāla, balts poliuretāns ap koka kodolu ar papildu izturīgu pārklājumu, divkameru stikla pakete	1.0	15-85	761,16 921,00	795,04 962,00	-	
GXL 2070	Manuāla, priedes koks, apstrādāts ar trīskāršu pārklājumu, balti krāsots, vienkameras stikla pakete	1.3	15-85	-	499,17 604,00	-	
GXL 2066	Manuāla, priedes koks, apstrādāts ar trīskāršu pārklājumu, balti krāsots, divkameru stikla pakete	1.0	15-85	-	698,35 845,00	-	

Pieslēgums jāiegādājas atsevišķi.

GXL/GXU jumta lūku var atvērt ar rokturi vērtnes vidū, vērtnes eņģu novietošanas puses var mainīt. GXL/GXU lūka atveras uz āru. Tā nav saderīga ar ārējiem aksesuāriem. Lai iegūtu papildinformāciju par GXL un GXU vara vai titāncinka uzlikām, lūdzu, sazinieties ar VELUX klientu servisu.



Cenas bez PVN, Eiro
Cenas ar PVN, Eiro

MK08
78x140

SK08
114x140

AVĀRIJAS IZEJA

		W/(m ² K)		Iebūvēšanas slīpums			
GTL 3070	Verama ar roku pa augšējo asi, rokturis apakšā, priedes koks, apstrādāts ar trīskāršu pārklājumu, caurspīdīgs lakojums, vienkameras stikla pakete	1.3	15-55	703,31 851,00	900,83 1 090,00		
GTL 3066	Verama ar roku pa augšējo asi, rokturis apakšā, priedes koks, apstrādāts ar trīskāršu pārklājumu, caurspīdīgs lakojums, divkameru stikla pakete	1.0	15-55	984,30 1 191,00	1 260,33 1 525,00		
GTU 0070	Verama ar roku pa augšējo asi, rokturis apakšā, balts poliuretāns ap koka kodolu ar papildu izturīgu pārklājumu, vienkameras stikla pakete	1.3	15-55	799,17 967,00	1 023,97 1 239,00		
GTU 0070	Verama ar roku pa augšējo asi, rokturis apakšā, balts poliuretāns ap koka kodolu ar papildu izturīgu pārklājumu, vienkameras stikla pakete	1.3	15-40	-	-		
GTU 0066	Verama ar roku pa augšējo asi, rokturis apakšā, balts poliuretāns ap koka kodolu ar papildu izturīgu pārklājumu, divkameru stikla pakete	1.0	15-55	1 119,01 1 354,00	1 433,06 1 734,00		
GTL 2070	Verama ar roku pa augšējo asi, rokturis apakšā, priedes koks, apstrādāts ar trīskāršu pārklājumu, balti krāsots, vienkameras stikla pakete	1.3	15-55	703,31 851,00	900,83 1 090,00		
GTL 2066	Verama ar roku pa augšējo asi, rokturis apakšā, priedes koks, apstrādāts ar trīskāršu pārklājumu, balti krāsots, divkameru stikla pakete	1.0	15-55	984,30 1 191,00	1 260,33 1 525,00		

Pieslēgums jāiegādājas atsevišķi.

Cenas bez PVN, Euro
Cenas ar PVN, Euro

Izmērs (cm)

+++
46x61

024
90x48

025
45x55

029
45x73

033
85x85

034
48x90

103
54x83

JUMTA LŪKAS NEAPKURINĀMIEM BĒNIŅIEM

Iebūvēšanas
slīpums

GVK 0000Z	Verama no sāna, vienkameras stikla pakete. Iekšējā virsma: poliuretāns, melna laka. Ārējais materiāls: alumīnijs, tumši pelēks.	20-65	166,12 201,00	-	-	-	-	-	-
VLT 1000	Verama no sāna, vienkameras stikla pakete. Iekšējā virsma: priedes koks, apstrādāts ar dubultu pārklājumu, caurspīdīgs lakojums. Ārējais materiāls: alumīnijs, tumši pelēks	20-45	-	140,50 170,00	-	-	-	-	-
VLT 1000	Uz kreiso vai labo pusi verama vērtne, vienkameras stikla pakete. Iekšējā virsma: priedes koks, apstrādāts ar dubultu pārklājumu, caurspīdīgs lakojums. Ārējais materiāls: alumīnijs, tumši pelēks.	20-60	-	-	108,26 131,00	119,01 144,00	238,02 288,00	-	-
VLT 1000	Verama no sāna vai no Augšas, vienkameras stikla pakete. Iekšējā virsma: priedes koks, apstrādāts ar dubultu pārklājumu, caurspīdīgs lakojums. Ārējais materiāls: alumīnijs, tumši pelēks.	20-60	-	-	-	-	-	146,28 177,00	-
GVT 0059Z	Verama no sāna, vienkameras stikla Pakete. Iekšējā virsma: poliuretāns, melna laka. Ārējais materiāls: alumīnijs, tumši pelēks.	20-65	-	-	-	-	-	-	228,93 277,00
GVT 7759Z	Verama no sāna, vienkameras stikla Pakete. Iekšējā virsma: poliuretāns, sarkana laka. Ārējais materiāls: PUR, ķieģeļu sarkans.	20-65	-	-	-	-	-	-	247,11 299,00

PIESLĒGUMI IEBŪVĒŠANAI SLĪPOS JUMTOS

Cenas bez PVN, Euro
Cenas ar PVN, Euro

Izmērs (cm)

CK02
55x78

CK04
55x98

CK06
55x118

FK04
66x98

FK06
66x118

FK08
66x140

MK04
78x98

MK06
78x118

VIENA LOGA IEBŪVĒŠANA

Hidroizolācijas risinājums 1000 ietver difūzijas membrānu BFX un drenāžas noteku

Iebūvēšanas
slīpums

Standarta iebūvēšanas līmenis (sarkanais līmenis)

Modelis	Apraksts	Izmērs	CK02	CK04	CK06	FK04	FK06	FK08	MK04	MK06
EDW 1000	Profilētiem jumta segumiem ar profila augstumu līdz 120 mm	15-90	104,13 126,00	106,61 129,00	110,74 134,00	110,74 134,00	119,83 145,00	125,62 152,00	119,83 145,00	125,62 152,00
EDT 1000	Plakaniem dakstiņiem 15-40 mm biezumā	20-90	104,13 126,00	106,61 129,00	110,74 134,00	110,74 134,00	119,83 145,00	125,62 152,00	119,83 145,00	125,62 152,00
EDS 1000	Plakaniem jumta segumiem ar augstumu līdz 16 mm (2 x 8 mm)	15-90	104,13 126,00	106,61 129,00	110,74 134,00	110,74 134,00	119,83 145,00	125,62 152,00	119,83 145,00	125,62 152,00
EDQ 1000L	Plakaniem metāla jumta segumiem ar click montāžas sistēmu un šuves augstumu no 25 līdz 35 mm	15-90	125,62 152,00	128,10 155,00	133,06 161,00	133,06 161,00	143,80 174,00	151,24 183,00	143,80 174,00	151,24 183,00
EDB 1000	Vienkāršu bebrastes dakstiņu jumtiem līdz 38 mm (2 x 19 mm)	25-90	104,13 126,00	106,61 129,00	110,74 134,00	110,74 134,00	119,83 145,00	125,62 152,00	119,83 145,00	125,62 152,00
EDL 1000	Jumta segumiem ar augstumu līdz 16 mm	15-90	104,13 126,00	106,61 129,00	110,74 134,00	110,74 134,00	119,83 145,00	125,62 152,00	119,83 145,00	125,62 152,00
EDP 1000	Vienkāršu dakstiņu jumtiem līdz 28 mm (2 x 14 mm)	25-90	104,13 126,00	106,61 129,00	110,74 134,00	110,74 134,00	119,83 145,00	125,62 152,00	119,83 145,00	125,62 152,00

Padziļināts iebūvēšanas līmenis 40 mm dziļāk jumta konstrukcijā (zilais līmenis)

EDJ 1000	Plakaniem vai profilētiem jumta segumiem ar augstumu līdz 90 mm	20-90	125,62 152,00	128,10 155,00	133,06 161,00	133,06 161,00	143,80 174,00	151,24 183,00	143,80 174,00	151,24 183,00
EDN 1000	Plakaniem jumta segumiem ar augstumu līdz 16 mm (2 x 8 mm)	20-90	125,62 152,00	128,10 155,00	133,06 161,00	133,06 161,00	143,80 174,00	151,24 183,00	143,80 174,00	151,24 183,00

Cenas bez PVN, Euro
Cenas ar PVN, Euro

Izmērs (cm)

CK02
55x78

CK04
55x98

CK06
55x118

FK04
66x98

FK06
66x118

FK08
66x140

MK04
78x98

MK06
78x118

HIDRO UN SILTUMIZOLĀCIJAS RISINĀJUMS 2000 IETVER DIFŪZIJAS MEMBRĀNU BFX, DRENĀŽAS NOTEKU UN SILTUMIZOLĀCIJAS RĀMI BDX













Iebūvēšanas
slīpums













Standarta iebūvēšanas līmenis (sarkanais līmenis)

Modelis	Apraksts	Izmērs	CK02	CK04	CK06	FK04	FK06	FK08	MK04	MK06
EDW 2000	Profilētiem jumta segumiem ar profila augstumu līdz 120 mm	15-90	121,49 147,00	123,97 150,00	128,93 156,00	128,93 156,00	138,84 168,00	146,28 177,00	138,84 168,00	146,28 177,00
EDT 2000	Plakaniem dakstiņiem 15-40 mm biezumā	20-90	121,49 147,00	123,97 150,00	128,93 156,00	128,93 156,00	138,84 168,00	146,28 177,00	138,84 168,00	146,28 177,00
EDS 2000	Plakaniem jumta segumiem ar augstumu līdz 16 mm (2 x 8 mm)	15-90	121,49 147,00	123,97 150,00	128,93 156,00	128,93 156,00	138,84 168,00	146,28 177,00	138,84 168,00	146,28 177,00
EDQ 2000L	Plakaniem metāla jumta segumiem ar click montāžas sistēmu un šuves augstumu no 25 līdz 35 mm	15-90	145,45 176,00	149,59 181,00	154,55 187,00	154,55 187,00	166,94 202,00	175,21 212,00	166,94 202,00	175,21 212,00
EDB 2000	Vienkāršu bebrastes dakstiņu jumtiem līdz 38 mm (2 x 19 mm)	25-90	121,49 147,00	123,97 150,00	128,93 156,00	128,93 156,00	138,84 168,00	146,28 177,00	138,84 168,00	146,28 177,00
EDL 2000	Jumta segumiem ar augstumu līdz 16 mm	15-90	121,49 147,00	123,97 150,00	128,93 156,00	128,93 156,00	138,84 168,00	146,28 177,00	138,84 168,00	146,28 177,00

Padziļināts iebūvēšanas līmenis 40 mm dziļāk jumta konstrukcijā (zilais līmenis)

EDJ 2000	Plakaniem vai profilētiem jumta segumiem ar augstumu līdz 90 mm	20-90	145,45 176,00	149,59 181,00	154,55 187,00	154,55 187,00	166,94 202,00	175,21 212,00	166,94 202,00	175,21 212,00
EDN 2000	Plakaniem jumta segumiem ar augstumu līdz 16 mm (2 x 8 mm)	20-90	145,45 176,00	149,59 181,00	154,55 187,00	154,55 187,00	166,94 202,00	175,21 212,00	166,94 202,00	175,21 212,00

	 MK08 78x140	 MK10 78x160	 MK12 78x180	 PK06 94x118	 PK08 94x140	 PK10 94x160	 SK06 114x118	 SK08 114x140	 SK10 114x160	 UK04 134x98	 UK08 134x140	 UK10 134x160
	133,06 161,00	147,11 178,00	149,59 181,00	142,15 172,00	149,59 181,00	154,55 187,00	148,76 180,00	157,02 190,00	163,64 198,00	157,02 190,00	169,42 205,00	188,43 228,00
	133,06 161,00	147,11 178,00	149,59 181,00	142,15 172,00	149,59 181,00	154,55 187,00	148,76 180,00	157,02 190,00	163,64 198,00	157,02 190,00	169,42 205,00	188,43 228,00
	133,06 161,00	147,11 178,00	149,59 181,00	142,15 172,00	149,59 181,00	154,55 187,00	148,76 180,00	157,02 190,00	163,64 198,00	157,02 190,00	169,42 205,00	188,43 228,00
	160,33 194,00	176,86 214,00	179,34 217,00	170,25 206,00	179,34 217,00	185,95 225,00	178,51 216,00	188,43 228,00	195,87 237,00	188,43 228,00	204,13 247,00	226,45 274,00
	133,06 161,00	147,11 178,00	149,59 181,00	142,15 172,00	149,59 181,00	154,55 187,00	148,76 180,00	157,02 190,00	163,64 198,00	157,02 190,00	169,42 205,00	188,43 228,00
	133,06 161,00	147,11 178,00	149,59 181,00	142,15 172,00	149,59 181,00	154,55 187,00	148,76 180,00	157,02 190,00	163,64 198,00	157,02 190,00	169,42 205,00	188,43 228,00
	133,06 161,00	147,11 178,00	-	142,15 172,00	149,59 181,00	154,55 187,00	148,76 180,00	157,02 190,00	163,64 198,00	157,02 190,00	169,42 205,00	188,43 228,00
	160,33 194,00	176,86 214,00	179,34 217,00	170,25 206,00	179,34 217,00	185,95 225,00	178,51 216,00	188,43 228,00	195,87 237,00	188,43 228,00	204,13 247,00	226,45 274,00
	160,33 194,00	176,86 214,00	179,34 217,00	170,25 206,00	179,34 217,00	185,95 225,00	178,51 216,00	188,43 228,00	195,87 237,00	188,43 228,00	204,13 247,00	226,45 274,00

	 MK08 78x140	 MK10 78x160	 MK12 78x180	 PK06 94x118	 PK08 94x140	 PK10 94x160	 SK06 114x118	 SK08 114x140	 SK10 114x160	 UK04 134x98	 UK08 134x140	 UK10 134x160
	155,37 188,00	171,07 207,00	174,38 211,00	165,29 200,00	174,38 211,00	180,17 218,00	172,73 209,00	182,64 221,00	190,08 230,00	182,64 221,00	197,52 239,00	219,83 266,00
	155,37 188,00	171,07 207,00	174,38 211,00	165,29 200,00	174,38 211,00	180,17 218,00	172,73 209,00	182,64 221,00	190,08 230,00	182,64 221,00	197,52 239,00	219,83 266,00
	155,37 188,00	171,07 207,00	174,38 211,00	165,29 200,00	174,38 211,00	180,17 218,00	172,73 209,00	182,64 221,00	190,08 230,00	182,64 221,00	197,52 239,00	219,83 266,00
	185,95 225,00	205,79 249,00	209,09 253,00	198,35 240,00	209,09 253,00	215,70 261,00	207,44 251,00	219,83 266,00	228,10 276,00	219,83 266,00	237,19 287,00	263,64 319,00
	155,37 188,00	171,07 207,00	174,38 211,00	165,29 200,00	174,38 211,00	180,17 218,00	172,73 209,00	182,64 221,00	190,08 230,00	182,64 221,00	197,52 239,00	219,83 266,00
	155,37 188,00	171,07 207,00	174,38 211,00	165,29 200,00	174,38 211,00	180,17 218,00	172,73 209,00	182,64 221,00	190,08 230,00	182,64 221,00	197,52 239,00	219,83 266,00
	185,95 225,00	205,79 249,00	209,09 253,00	198,35 240,00	209,09 253,00	215,70 261,00	207,44 251,00	219,83 266,00	228,10 276,00	219,83 266,00	237,19 287,00	263,64 319,00
	185,95 225,00	205,79 249,00	209,09 253,00	198,35 240,00	209,09 253,00	215,70 261,00	207,44 251,00	219,83 266,00	228,10 276,00	219,83 266,00	237,19 287,00	263,64 319,00

Cenas bez PVN, Euro
Cenas ar PVN, Euro

Izmērs (cm)

CK02
55x78

CK04
55x98

FK04
66x98

FK06
66x118

MK04
78x98

MK06
78x118

MK08
78x140

MK10
78x160

LOGA NOMAIŅAS PIESLĒGUMS

Pieslēgums bez BFX

Iebūvēšanas
slīpums

			CK02	CK04	FK04	FK06	MK04	MK06	MK08	MK10
EW 0000	Profilētiem jumta segumiem ar profila augstumu līdz 120 mm	15-90	67,77 82,00	69,42 84,00	71,90 87,00	77,69 94,00	77,69 94,00	81,82 99,00	86,78 105,00	95,87 116,00
EL 0000	Jumta segumiem ar augstumu līdz 16 mm	15-90	67,77 82,00	69,42 84,00	71,90 87,00	77,69 94,00	77,69 94,00	81,82 99,00	86,78 105,00	95,87 116,00
ELX 0000	Visiem jumta segumiem	15-80	67,77 82,00	69,42 84,00	71,90 87,00	77,69 94,00	77,69 94,00	81,82 99,00	86,78 105,00	95,87 116,00

Šie nomainās pieslēgumi piemēroti vecākas paaudzes jumta logiem, kas ražoti līdz 2002. gadam.

Cenas bez PVN, Euro
Cenas ar PVN, Euro

Izmērs (cm)

CK02
55x78

CK04
55x98

CK06
55x118

FK04
66x98

FK06
66x118

MK04
78x98

MK06
78x118









MK08
78x140











LOGA NOMAIŅAS PIESLĒGUMI AR SILTUMIZOLĀCIJU UN BFX

Iebūvēšanas
slīpums

			CK02	CK04	CK06	FK04	FK06	MK04	MK06	MK08
EW 6000	Profilētiem jumta segumiem ar profila augstumu līdz 120 mm	15-90	133,06 161,00	136,36 165,00	141,32 171,00	141,32 171,00	152,07 184,00	152,07 184,00	160,33 194,00	170,25 206,00
EL 6000	Jumta segumiem ar augstumu līdz 16 mm	15-90	133,06 161,00	136,36 165,00	141,32 171,00	141,32 171,00	152,07 184,00	152,07 184,00	160,33 194,00	170,25 206,00

Šie nomainās pieslēgumi piemēroti vecākas paaudzes jumta logiem, kas ražoti līdz 2002. gadam.

 PK06 94x118	 PK08 94x140	 PK10 94x160	 SK06 114x118	 SK08 114x140	 SK10 114x160	 UK04 134x98	 UK08 134x140	 UK10 134x160
92,56 112,00	97,52 118,00	100,83 122,00	96,69 117,00	102,48 124,00	106,61 129,00	102,48 124,00	110,74 134,00	123,14 149,00
92,56 112,00	97,52 118,00	100,83 122,00	96,69 117,00	102,48 124,00	106,61 129,00	102,48 124,00	110,74 134,00	123,14 149,00
92,56 112,00	97,52 118,00	100,83 122,00	96,69 117,00	102,48 124,00	106,61 129,00	102,48 124,00	110,74 134,00	123,14 149,00

 MK10 78x160	 PK06 94x118	 PK08 94x140	 PK10 94x160	 SK06 114x118	 SK08 114x140	 SK10 114x160	 UK04 134x98	 UK08 134x140	 UK10 134x160
187,60 227,00	180,99 219,00	190,91 231,00	197,52 239,00	189,26 229,00	200,00 242,00	208,26 252,00	200,00 242,00	216,53 262,00	240,50 291,00
187,60 227,00	180,99 219,00	190,91 231,00	197,52 239,00	189,26 229,00	200,00 242,00	208,26 252,00	200,00 242,00	216,53 262,00	240,50 291,00

Jaunums
2024

Cenas bez PVN, Eiro
Cenas ar PVN, Eiro

Izmērs (cm)

CK02
55x78

CK04
55x98

CK06
55x118

FK04
66x98

FK06
66x118

FK08
66x140

MK04
78x98

MK06
78x118

KOMBINĒTO LOGU IEBŪVĒŠANA, PIELĀGOJAMA SAVIENOJOŠĀ DETALĀ

Iebūvēšanas
slīpums

Standarta iebūvēšanas līmenis (sarkanais līmenis)

EKW 2001M	Profilētiem jumta segumiem ar profila augstumu līdz 120 mm	15-90	121,49 147,00	123,97 150,00	128,93 156,00	128,93 156,00	138,84 168,00	146,28 177,00	138,84 168,00	146,28 177,00
EKW 2002M	Profilētiem jumta segumiem ar profila augstumu līdz 120 mm	15-90	121,49 147,00	123,97 150,00	128,93 156,00	128,93 156,00	138,84 168,00	146,28 177,00	138,84 168,00	146,28 177,00
EKW 2003M	Profilētiem jumta segumiem ar profila augstumu līdz 120 mm	15-90	121,49 147,00	123,97 150,00	128,93 156,00	128,93 156,00	138,84 168,00	146,28 177,00	138,84 168,00	146,28 177,00
EKW 2004ME	Profilētiem jumta segumiem ar profila augstumu līdz 120 mm	15-90	121,49 147,00	123,97 150,00	128,93 156,00	128,93 156,00	138,84 168,00	146,28 177,00	138,84 168,00	146,28 177,00
EKW 2004MJ	Profilētiem jumta segumiem ar profila augstumu līdz 120 mm	15-90	121,49 147,00	123,97 150,00	128,93 156,00	128,93 156,00	138,84 168,00	146,28 177,00	138,84 168,00	146,28 177,00
EKW 2006ME	Profilētiem jumta segumiem ar profila augstumu līdz 120 mm	15-90	121,49 147,00	123,97 150,00	128,93 156,00	128,93 156,00	138,84 168,00	146,28 177,00	138,84 168,00	146,28 177,00
EKW 2006MJ	Profilētiem jumta segumiem ar profila augstumu līdz 120 mm	15-90	121,49 147,00	123,97 150,00	128,93 156,00	128,93 156,00	138,84 168,00	146,28 177,00	138,84 168,00	146,28 177,00
EKW 2007ME	Profilētiem jumta segumiem ar profila augstumu līdz 120 mm	15-90	121,49 147,00	123,97 150,00	128,93 156,00	128,93 156,00	138,84 168,00	146,28 177,00	138,84 168,00	146,28 177,00
EKW 2007MJ	Profilētiem jumta segumiem ar profila augstumu līdz 120 mm	15-90	121,49 147,00	123,97 150,00	128,93 156,00	128,93 156,00	138,84 168,00	146,28 177,00	138,84 168,00	146,28 177,00
EKW 2021M	Profilētiem jumta segumiem ar profila augstumu līdz 120 mm	15-90	242,98 294,00	247,93 300,00	257,85 312,00	257,85 312,00	277,69 336,00	292,56 354,00	277,69 336,00	292,56 354,00
EKS 2001M	Plakaniem jumta segumiem ar augstumu līdz 16 mm (2 x 8 mm)	15-90	121,49 147,00	123,97 150,00	128,93 156,00	128,93 156,00	138,84 168,00	146,28 177,00	138,84 168,00	146,28 177,00
EKS 2002M	Plakaniem jumta segumiem ar augstumu līdz 16 mm (2 x 8 mm)	15-90	121,49 147,00	123,97 150,00	128,93 156,00	128,93 156,00	138,84 168,00	146,28 177,00	138,84 168,00	146,28 177,00
EKS 2003M	Plakaniem jumta segumiem ar augstumu līdz 16 mm (2 x 8 mm)	15-90	121,49 147,00	123,97 150,00	128,93 156,00	128,93 156,00	138,84 168,00	146,28 177,00	138,84 168,00	146,28 177,00
EKS 2004ME	Plakaniem jumta segumiem ar augstumu līdz 16 mm (2 x 8 mm)	15-90	121,49 147,00	123,97 150,00	128,93 156,00	128,93 156,00	138,84 168,00	146,28 177,00	138,84 168,00	146,28 177,00
EKS 2004MJ	Plakaniem jumta segumiem ar augstumu līdz 16 mm (2 x 8 mm)	15-90	121,49 147,00	123,97 150,00	128,93 156,00	128,93 156,00	138,84 168,00	146,28 177,00	138,84 168,00	146,28 177,00
EKS 2006ME	Plakaniem jumta segumiem ar augstumu līdz 16 mm (2 x 8 mm)	15-90	121,49 147,00	123,97 150,00	128,93 156,00	128,93 156,00	138,84 168,00	146,28 177,00	138,84 168,00	146,28 177,00
EKS 2006MJ	Plakaniem jumta segumiem ar augstumu līdz 16 mm (2 x 8 mm)	15-90	121,49 147,00	123,97 150,00	128,93 156,00	128,93 156,00	138,84 168,00	146,28 177,00	138,84 168,00	146,28 177,00
EKS 2007ME	Plakaniem jumta segumiem ar augstumu līdz 16 mm (2 x 8 mm)	15-90	121,49 147,00	123,97 150,00	128,93 156,00	128,93 156,00	138,84 168,00	146,28 177,00	138,84 168,00	146,28 177,00
EKS 2007MJ	Plakaniem jumta segumiem ar augstumu līdz 16 mm (2 x 8 mm)	15-90	121,49 147,00	123,97 150,00	128,93 156,00	128,93 156,00	138,84 168,00	146,28 177,00	138,84 168,00	146,28 177,00
EKS 2021M	Plakaniem jumta segumiem ar augstumu līdz 16 mm (2 x 8 mm)	15-90	242,98 294,00	247,93 300,00	257,85 312,00	257,85 312,00	277,69 336,00	292,56 354,00	277,69 336,00	292,56 354,00
EKQ 2001M	Plakaniem metāla jumta segumiem ar click montāžas sistēmu un šuves augstumu no 25 līdz 35 mm	15-90	121,49 147,00	123,97 150,00	128,93 156,00	128,93 156,00	138,84 168,00	146,28 177,00	138,84 168,00	146,28 177,00
EKQ 2002M	Plakaniem metāla jumta segumiem ar click montāžas sistēmu un šuves augstumu no 25 līdz 35 mm	15-90	121,49 147,00	123,97 150,00	128,93 156,00	128,93 156,00	138,84 168,00	146,28 177,00	138,84 168,00	146,28 177,00
EKQ 2003M	Plakaniem metāla jumta segumiem ar click montāžas sistēmu un šuves augstumu no 25 līdz 35 mm	15-90	121,49 147,00	123,97 150,00	128,93 156,00	128,93 156,00	138,84 168,00	146,28 177,00	138,84 168,00	146,28 177,00
EKQ 2004ME	Plakaniem metāla jumta segumiem ar click montāžas sistēmu un šuves augstumu no 25 līdz 35 mm	15-90	121,49 147,00	123,97 150,00	128,93 156,00	128,93 156,00	138,84 168,00	146,28 177,00	138,84 168,00	146,28 177,00
EKQ 2004MJ	Plakaniem metāla jumta segumiem ar click montāžas sistēmu un šuves augstumu no 25 līdz 35 mm	15-90	121,49 147,00	123,97 150,00	128,93 156,00	128,93 156,00	138,84 168,00	146,28 177,00	138,84 168,00	146,28 177,00
EKQ 2006ME	Plakaniem metāla jumta segumiem ar click montāžas sistēmu un šuves augstumu no 25 līdz 35 mm	15-90	121,49 147,00	123,97 150,00	128,93 156,00	128,93 156,00	138,84 168,00	146,28 177,00	138,84 168,00	146,28 177,00
EKQ 2006MJ	Plakaniem metāla jumta segumiem ar click montāžas sistēmu un šuves augstumu no 25 līdz 35 mm	15-90	121,49 147,00	123,97 150,00	128,93 156,00	128,93 156,00	138,84 168,00	146,28 177,00	138,84 168,00	146,28 177,00

Cenas bez PVN, Euro
Cenas ar PVN, Euro

Izmērs (cm)

CK02
55x78

CK04
55x98

CK06
55x118

FK04
66x98

FK06
66x118

FK08
66x140

MK04
78x98













MK06
78x118

KOMBINĒTO LOGU IEBŪVĒŠANA, PIELĀGOJAMA SAVIENOJOŠĀ DETALĀ

Iebūvēšanas
slīpums

Standarta iebūvēšanas līmenis (sarkanais līmenis)

			CK02	CK04	CK06	FK04	FK06	FK08	MK04	MK06	
EKQ 2007ME	Plakaniem metāla jumta segumiem ar click montāžas sistēmu un šuves augstumu no 25 līdz 35 mm	15-90	121,49 147,00	123,97 150,00	128,93 156,00	128,93 156,00	138,84 168,00	146,28 177,00	138,84 168,00	146,28 177,00	
EKQ 2007MJ	Plakaniem metāla jumta segumiem ar click montāžas sistēmu un šuves augstumu no 25 līdz 35 mm	15-90	121,49 147,00	123,97 150,00	128,93 156,00	128,93 156,00	138,84 168,00	146,28 177,00	138,84 168,00	146,28 177,00	
EKL 2001M	Jumta segumiem ar augstumu līdz 16 mm	15-90	121,49 147,00	123,97 150,00	128,93 156,00	128,93 156,00	138,84 168,00	146,28 177,00	138,84 168,00	146,28 177,00	
EKL 2002M	Jumta segumiem ar augstumu līdz 16 mm	15-90	121,49 147,00	123,97 150,00	128,93 156,00	128,93 156,00	138,84 168,00	146,28 177,00	138,84 168,00	146,28 177,00	
EKL 2003M	Jumta segumiem ar augstumu līdz 16 mm	15-90	121,49 147,00	123,97 150,00	128,93 156,00	128,93 156,00	138,84 168,00	146,28 177,00	138,84 168,00	146,28 177,00	
EKL 2004ME	Jumta segumiem ar augstumu līdz 16 mm	15-90	121,49 147,00	123,97 150,00	128,93 156,00	128,93 156,00	138,84 168,00	146,28 177,00	138,84 168,00	146,28 177,00	
EKL 2004MJ	Jumta segumiem ar augstumu līdz 16 mm	15-90	121,49 147,00	123,97 150,00	128,93 156,00	128,93 156,00	138,84 168,00	146,28 177,00	138,84 168,00	146,28 177,00	
EKL 2006ME	Jumta segumiem ar augstumu līdz 16 mm	15-90	121,49 147,00	123,97 150,00	128,93 156,00	128,93 156,00	138,84 168,00	146,28 177,00	138,84 168,00	146,28 177,00	
EKL 2006MJ	Jumta segumiem ar augstumu līdz 16 mm	15-90	121,49 147,00	123,97 150,00	128,93 156,00	128,93 156,00	138,84 168,00	146,28 177,00	138,84 168,00	146,28 177,00	
EKL 2007ME	Jumta segumiem ar augstumu līdz 16 mm	15-90	121,49 147,00	123,97 150,00	128,93 156,00	128,93 156,00	138,84 168,00	146,28 177,00	138,84 168,00	146,28 177,00	
EKL 2007MJ	Jumta segumiem ar augstumu līdz 16 mm	15-90	121,49 147,00	123,97 150,00	128,93 156,00	128,93 156,00	138,84 168,00	146,28 177,00	138,84 168,00	146,28 177,00	
EKL 2021M	Jumta segumiem ar augstumu līdz 16 mm	15-90	242,98 294,00	247,93 300,00	257,85 312,00	257,85 312,00	277,69 336,00	292,56 354,00	277,69 336,00	292,56 354,00	

	 MK08 78x140	 MK10 78x160	 MK12 78x180	 PK06 94x118	 PK08 94x140	 PK10 94x160	 SK06 114x118	 SK08 114x140	 SK10 114x160	 UK04 134x98	 UK08 134x140	 UK10 134x160
	155,37 188,00	171,07 207,00	174,38 211,00	165,29 200,00	174,38 211,00	180,17 218,00	172,73 209,00	182,64 221,00	190,08 230,00	182,64 221,00	197,52 239,00	219,83 266,00
	155,37 188,00	171,07 207,00	174,38 211,00	165,29 200,00	174,38 211,00	180,17 218,00	172,73 209,00	182,64 221,00	190,08 230,00	182,64 221,00	197,52 239,00	219,83 266,00
	155,37 188,00	171,07 207,00	174,38 211,00	165,29 200,00	174,38 211,00	180,17 218,00	172,73 209,00	182,64 221,00	190,08 230,00	182,64 221,00	197,52 239,00	219,83 266,00
	155,37 188,00	171,07 207,00	174,38 211,00	165,29 200,00	174,38 211,00	180,17 218,00	172,73 209,00	182,64 221,00	190,08 230,00	182,64 221,00	197,52 239,00	219,83 266,00
	155,37 188,00	171,07 207,00	174,38 211,00	165,29 200,00	174,38 211,00	180,17 218,00	172,73 209,00	182,64 221,00	190,08 230,00	182,64 221,00	197,52 239,00	219,83 266,00
	155,37 188,00	171,07 207,00	174,38 211,00	165,29 200,00	174,38 211,00	180,17 218,00	172,73 209,00	182,64 221,00	190,08 230,00	182,64 221,00	197,52 239,00	219,83 266,00
	155,37 188,00	171,07 207,00	-	165,29 200,00	174,38 211,00	180,17 218,00	172,73 209,00	182,64 221,00	190,08 230,00	182,64 221,00	197,52 239,00	219,83 266,00
	155,37 188,00	171,07 207,00	174,38 211,00	165,29 200,00	174,38 211,00	180,17 218,00	172,73 209,00	182,64 221,00	190,08 230,00	182,64 221,00	197,52 239,00	219,83 266,00
	155,37 188,00	171,07 207,00	-	165,29 200,00	174,38 211,00	180,17 218,00	172,73 209,00	182,64 221,00	190,08 230,00	182,64 221,00	197,52 239,00	219,83 266,00
	155,37 188,00	171,07 207,00	174,38 211,00	165,29 200,00	174,38 211,00	180,17 218,00	172,73 209,00	182,64 221,00	190,08 230,00	182,64 221,00	197,52 239,00	219,83 266,00
	155,37 188,00	171,07 207,00	-	165,29 200,00	174,38 211,00	180,17 218,00	172,73 209,00	182,64 221,00	190,08 230,00	182,64 221,00	197,52 239,00	219,83 266,00
	310,74 376,00	342,15 414,00	348,76 422,00	330,58 400,00	348,76 422,00	360,33 436,00	345,45 418,00	365,29 442,00	380,17 460,00	365,29 442,00	395,04 478,00	439,67 532,00

Cenas bez PVN, Euro
Cenas ar PVN, Euro

Izmērs (cm)

CK02
55x78

CK04
55x98

CK06
55x118

FK04
66x98

FK06
66x118

FK08
66x140

MK04
78x98

MK06
78x118

KOMBINĒTĀ IEBŪVĒŠANA

Horizontālas un vertikālas kombinācijas

Iebūvēšanas
slīpums

Standarta iebūvēšanas līmenis (sarkanais līmenis)

EKT 0001E (F, G, H)*	Plakaniem dakstiņiem 15–40 mm biezumā	20–90	85,12 103,00	86,78 105,00	90,08 109,00	90,08 109,00	97,52 118,00	102,48 124,00	97,52 118,00	102,48 124,00
EKT 0002E (F, G, H)*	Plakaniem dakstiņiem 15–40 mm biezumā	20–90	85,12 103,00	86,78 105,00	90,08 109,00	90,08 109,00	97,52 118,00	102,48 124,00	97,52 118,00	102,48 124,00
EKT 0003	Plakaniem dakstiņiem 15–40 mm biezumā	20–90	85,12 103,00	86,78 105,00	90,08 109,00	90,08 109,00	97,52 118,00	102,48 124,00	97,52 118,00	102,48 124,00
EKB 0003	Vienkāršu bebrastes dakstiņu jumtiem līdz 38 mm (2 x 19 mm)	25–90	85,12 103,00	86,78 105,00	90,08 109,00	90,08 109,00	97,52 118,00	102,48 124,00	97,52 118,00	102,48 124,00
EKB 0004EE (EJ, FE, FJ, GE, GJ, HE, HJ)**	Vienkāršu bebrastes dakstiņu jumtiem līdz 38 mm (2 x 19 mm)	25–90	85,12 103,00	86,78 105,00	90,08 109,00	90,08 109,00	97,52 118,00	102,48 124,00	97,52 118,00	102,48 124,00
EKB 0006E (J)	Vienkāršu bebrastes dakstiņu jumtiem līdz 38 mm (2 x 19 mm)	25–90	85,12 103,00	86,78 105,00	90,08 109,00	90,08 109,00	97,52 118,00	102,48 124,00	97,52 118,00	102,48 124,00
EKB 0007E (J)	Vienkāršu bebrastes dakstiņu jumtiem līdz 38 mm (2 x 19 mm)	25–90	85,12 103,00	86,78 105,00	90,08 109,00	90,08 109,00	97,52 118,00	102,48 124,00	97,52 118,00	102,48 124,00
EKP 0002E (F, G, H)*	Vienkāršu dakstiņu jumtiem līdz 28 mm (2 x 14 mm)	25–90	85,12 103,00	86,78 105,00	90,08 109,00	–	97,52 118,00	–	97,52 118,00	102,48 124,00
EKP 0021E (F, G, H)*	Vienkāršu dakstiņu jumtiem līdz 28 mm (2 x 14 mm)	25–90	170,25 206,00	173,55 210,00	180,17 218,00	–	195,04 236,00	–	195,04 236,00	204,96 248,00

Padziļināts iebūvēšanas līmenis 40 mm dziļāk jumta konstrukcijā (zilais līmenis)

EKJ 0001E (F, G, H)*	Plakaniem vai profilētiem jumta segumiem ar augstumu līdz 90 mm	20–90	101,65 123,00	104,13 126,00	108,26 131,00	108,26 131,00	116,53 141,00	123,14 149,00	116,53 141,00	123,14 149,00
EKJ 0002E (F, G, H)*	Plakaniem vai profilētiem jumta segumiem ar augstumu līdz 90 mm	20–90	101,65 123,00	104,13 126,00	108,26 131,00	108,26 131,00	116,53 141,00	123,14 149,00	116,53 141,00	123,14 149,00
EKJ 0003	Plakaniem vai profilētiem jumta segumiem ar augstumu līdz 90 mm	20–90	101,65 123,00	104,13 126,00	108,26 131,00	108,26 131,00	116,53 141,00	123,14 149,00	116,53 141,00	123,14 149,00
EKJ 0004EE (EJ, FE, FJ, GE, GJ, HE, HJ)**	Plakaniem vai profilētiem jumta segumiem ar augstumu līdz 90 mm	20–90	101,65 123,00	104,13 126,00	108,26 131,00	108,26 131,00	116,53 141,00	123,14 149,00	116,53 141,00	123,14 149,00
EKJ 0006E (J)	Plakaniem vai profilētiem jumta segumiem ar augstumu līdz 90 mm	20–90	101,65 123,00	104,13 126,00	108,26 131,00	108,26 131,00	116,53 141,00	123,14 149,00	116,53 141,00	123,14 149,00
EKJ 0007E (J)	Plakaniem vai profilētiem jumta segumiem ar augstumu līdz 90 mm	20–90	101,65 123,00	104,13 126,00	108,26 131,00	108,26 131,00	116,53 141,00	123,14 149,00	116,53 141,00	123,14 149,00
EKN 0001E (F, G, H)*	Plakaniem jumta segumiem ar augstumu līdz 16 mm (2 x 8 mm)	20–90	101,65 123,00	104,13 126,00	108,26 131,00	108,26 131,00	116,53 141,00	123,14 149,00	116,53 141,00	123,14 149,00
EKN 0002E (F, G, H)*	Plakaniem jumta segumiem ar augstumu līdz 16 mm (2 x 8 mm)	20–90	101,65 123,00	104,13 126,00	108,26 131,00	108,26 131,00	116,53 141,00	123,14 149,00	116,53 141,00	123,14 149,00
EKN 0003	Plakaniem jumta segumiem ar augstumu līdz 16 mm (2 x 8 mm)	20–90	101,65 123,00	104,13 126,00	108,26 131,00	108,26 131,00	116,53 141,00	123,14 149,00	116,53 141,00	123,14 149,00
EKN 0004EE (EJ, FE, FJ, GE, GJ, HE, HJ)**	Plakaniem jumta segumiem ar augstumu līdz 16 mm (2 x 8 mm)	20–90	101,65 123,00	104,13 126,00	108,26 131,00	108,26 131,00	116,53 141,00	123,14 149,00	116,53 141,00	123,14 149,00
EKN 0006E (J)	Plakaniem jumta segumiem ar augstumu līdz 16 mm (2 x 8 mm)	20–90	101,65 123,00	104,13 126,00	108,26 131,00	108,26 131,00	116,53 141,00	123,14 149,00	116,53 141,00	123,14 149,00
EKN 0007E (J)	Plakaniem jumta segumiem ar augstumu līdz 16 mm (2 x 8 mm)	20–90	101,65 123,00	104,13 126,00	108,26 131,00	108,26 131,00	116,53 141,00	123,14 149,00	116,53 141,00	123,14 149,00

* E = rāmju attālums 100 mm, F = rāmju attālums 120 mm, G = rāmju attālums 140 mm, H = rāmju attālums 160 mm

** Rāmju attālums mm (horizontāli/vertikāli): EE – 100/100, EJ – 100/250, FE – 120/100, FJ – 120/250, GE – 140/100, GJ – 140/250, HE – 160/100, HJ – 160/250

Izmērs (cm)

CK02

CK04

CK06

FK04

FK06

FK08

MK04

MK06

KOMBINĒTĀS IEBŪVĒŠANAS KOMPLEKTS IETVER: PIESLĒGUMU DIVIEM LOGIEM BLAKUS, BDX SILTUMIZOLĀCIJU, BFX DIFŪZIJAS MEMBRĀNU UN DRENĀŽAS NOTEKU, SPĀRI STARP LOGIEM UN TĀS DEKORATĪVU PĀRSEGU.

Logi ar 100 mm atstarpi

Iebūvēšanas
slīpums

Standarta iebūvēšanas līmenis (sarkanais līmenis)

Kods	Apraksts	Izmērs (cm)	CK02	CK04	CK06	FK04	FK06	FK08	MK04	MK06
EKW 4021E2	Profilētiem jumta segumiem ar profila augstumu līdz 120 mm	15-90	411,58 498,00	443,80 537,00	471,90 571,00	459,50 556,00	497,52 602,00	544,62 659,00	485,95 588,00	519,00 628,00
EKW 4021E3	Profilētiem jumta segumiem ar profila augstumu līdz 120 mm	15-90	411,58 498,00	443,80 537,00	471,90 571,00	459,50 556,00	497,52 602,00	544,62 659,00	485,95 588,00	519,00 628,00
EKT 4021E	Plakaniem dakstiņiem 15-40 mm biezumā	20-90	427,27 517,00	435,55 527,00	448,76 543,00	454,54 550,00	484,29 586,00	505,78 612,00	490,90 594,00	512,39 620,00
EKS 4021E2	Plakaniem jumta segumiem ar augstumu līdz 16 mm (2 x 8 mm)	15-90	411,58 498,00	443,80 537,00	471,90 571,00	459,50 556,00	497,52 602,00	544,62 659,00	485,95 588,00	519,00 628,00
EKS 4021E3	Plakaniem jumta segumiem ar augstumu līdz 16 mm (2 x 8 mm)	15-90	411,58 498,00	443,80 537,00	471,90 571,00	459,50 556,00	497,52 602,00	544,62 659,00	485,95 588,00	519,00 628,00
EKB 4021E	Vienkāršu bebrastes dakstiņu jumtiem līdz 38 mm (2 x 19 mm)	25-90	427,28 517,00	435,54 527,00	448,77 543,00	454,55 550,00	484,29 586,00	505,78 612,00	490,90 594,00	512,39 620,00
EKL 4021E2	Jumta segumiem ar augstumu līdz 16 mm	15-90	411,58 498,00	443,80 537,00	471,90 571,00	459,50 556,00	497,52 602,00	544,62 659,00	485,95 588,00	519,00 628,00
EKL 4021E3	Jumta segumiem ar augstumu līdz 16 mm	15-90	411,58 498,00	443,80 537,00	471,90 571,00	459,50 556,00	497,52 602,00	544,62 659,00	485,95 588,00	519,00 628,00
EKP 4021E	Vienkāršu dakstiņu jumtiem līdz 28 mm (2 x 14 mm)	25-90	427,28 517,00	435,54 527,00	448,77 543,00	-	484,29 586,00	-	490,90 594,00	512,39 620,00

Padziļināts iebūvēšanas līmenis 40 mm dziļāk jumta konstrukcijā (zilais līmenis)

EKJ 4021E	Plakaniem vai profilētiem jumta segumiem ar augstumu līdz 90 mm	20-90	460,33 557,00	470,25 569,00	485,12 587,00	490,90 594,00	522,31 632,00	547,10 662,00	528,92 640,00	553,71 670,00
-----------	---	-------	-------------------------	-------------------------	-------------------------	-------------------------	-------------------------	-------------------------	-------------------------	-------------------------

Logi ar 18 mm atstarpi

Standarta iebūvēšanas līmenis (sarkanais līmenis)

Kods	Apraksts	Izmērs (cm)	CK02	CK04	CK06	FK04	FK06	FK08	MK04	MK06
EBW 4021B	Profilētiem jumta segumiem ar profila augstumu līdz 120 mm	15-90	457,86 554,00	466,95 565,00	481,00 582,00	486,78 589,00	518,18 627,00	542,15 656,00	524,79 635,00	548,76 664,00
EBS 4021B	Plakaniem jumta segumiem ar augstumu līdz 16 mm (2 x 8 mm)	15-90	445,46 539,00	453,72 549,00	466,95 565,00	472,73 572,00	504,13 610,00	526,45 637,00	510,74 618,00	533,06 645,00
EBL 4021B	Jumta segumiem ar augstumu līdz 16 mm	15-90	445,46 539,00	453,72 549,00	466,95 565,00	472,73 572,00	504,13 610,00	526,45 637,00	510,74 618,00	533,06 645,00
EBP 4021B	Vienkāršu dakstiņu jumtiem līdz 28 mm (2 x 14 mm)	25-90	445,46 539,00	453,72 549,00	466,95 565,00	-	504,13 610,00	-	510,74 618,00	533,06 645,00

Iebūvēšanas komplekts ir saderīgs ar visu veidu VELUX jumta logiem. Jumta logi nav iekļauti, tie jāpasūta atsevišķi. Lai iegūtu vairāk informācijas, lūdzu sazināties ar VELUX klientu servisu.

	MK08	MK10	MK12	PK06	PK08	PK10	SK06	SK08	SK10	UK04	UK08
	569,41 689,00	629,75 762,00	-	569,42 689,00	619,83 750,00	660,33 799,00	609,91 738,00	661,98 801,00	705,79 854,00	625,62 757,00	705,78 854,00
	569,41 689,00	629,75 762,00	-	569,42 689,00	619,83 750,00	660,33 799,00	609,91 738,00	661,98 801,00	705,79 854,00	625,62 757,00	705,78 854,00
	536,35 649,00	584,28 707,00	-	579,33 701,00	604,14 731,00	621,49 752,00	625,62 757,00	656,20 794,00	676,86 819,00	670,25 811,00	711,58 861,00
	569,41 689,00	629,75 762,00	-	569,42 689,00	619,83 750,00	660,33 799,00	609,91 738,00	661,98 801,00	705,79 854,00	625,62 757,00	705,78 854,00
	569,41 689,00	629,75 762,00	-	569,42 689,00	619,83 750,00	660,33 799,00	609,91 738,00	661,98 801,00	705,79 854,00	625,62 757,00	705,78 854,00
	536,36 649,00	584,29 707,00	-	579,33 701,00	604,14 731,00	621,49 752,00	625,62 757,00	656,20 794,00	676,86 819,00	670,25 811,00	711,57 861,00
	569,41 689,00	629,75 762,00	-	569,42 689,00	619,83 750,00	660,33 799,00	609,91 738,00	661,98 801,00	705,79 854,00	625,62 757,00	705,78 854,00
	569,41 689,00	629,75 762,00	-	569,42 689,00	619,83 750,00	660,33 799,00	609,91 738,00	661,98 801,00	705,79 854,00	625,62 757,00	705,78 854,00
	536,36 649,00	-	-	-	604,14 731,00	621,49 752,00	625,62 757,00	-	-	670,25 811,00	711,57 861,00
	580,99 703,00	632,22 765,00	641,32 776,00	625,61 757,00	653,72 791,00	672,73 814,00	673,56 815,00	707,44 856,00	729,74 883,00	721,49 873,00	767,78 929,00
	576,03 697,00	626,44 758,00		620,66 751,00	648,76 785,00	666,95 807,00	669,42 810,00	701,65 849,00	724,80 877,00	715,70 866,00	761,98 922,00
	560,33 678,00	609,09 737,00		603,30 730,00	629,75 762,00	647,94 784,00	651,24 788,00	682,65 826,00	704,96 853,00	696,70 843,00	741,32 897,00
	560,33 678,00	609,09 737,00		603,30 730,00	629,75 762,00	647,94 784,00	651,24 788,00	682,65 826,00	704,96 853,00	696,70 843,00	741,32 897,00
	560,33 678,00	-		-	629,75 762,00	647,94 784,00	651,24 788,00	-	-	696,70 843,00	741,32 897,00

Cenas bez PVN, Euro
Cenas ar PVN, Euro

		Izmērs (cm)	CK02	CK04	CK06	FK04	FK06	FK08	MK04	MK06	
IEBŪVĒŠANAS KOMPLEKTS TRĪS KOMBINĒTU LOGU IEBŪVĒŠANAI, KAS NOVĪETOTI RINDĀ (VIENS-BLAKUS-OTRAM) IETVER PIESLĒGUMU, SILTUMIZOLĀCIJAS RĀMI BDX, DIFŪZIJAS MEMBRĀNU BFX UN DRENĀŽAS NOTEKU, KĀ ARĪ SPĀRES STARP LOGIEM UN TO DEKORATĪVOS PĀRSEGUS.											
Logi ar 100 mm atstarpi											
Iebūvēšanas slīpums											
Standarta iebūvēšanas līmenis (sarkanais līmenis)											
EKW 4031E2	Profilētiem jumta segumiem ar profila augstumu līdz 120 mm	15-90	651,25 788,00	713,22 863,00	764,46 925,00	753,72 912,00	819,83 992,00	906,60 1 097,00	797,52 965,00	856,19 1 036,00	
EKW 4031E3	Profilētiem jumta segumiem ar profila augstumu līdz 120 mm	15-90	651,25 788,00	713,22 863,00	764,46 925,00	753,72 912,00	819,83 992,00	906,60 1 097,00	797,52 965,00	856,19 1 036,00	
EKS 4031E2	Plakaniem jumta segumiem ar augstumu līdz 16 mm (2 x 8 mm)	15-90	651,25 788,00	713,22 863,00	764,46 925,00	753,72 912,00	819,83 992,00	906,60 1 097,00	797,52 965,00	856,19 1 036,00	
EKS 4031E3	Plakaniem jumta segumiem ar augstumu līdz 16 mm (2 x 8 mm)	15-90	651,25 788,00	713,22 863,00	764,46 925,00	753,72 912,00	819,83 992,00	906,60 1 097,00	797,52 965,00	856,19 1 036,00	
EKL 4031E2	Jumta segumiem ar augstumu līdz 16 mm	15-90	651,25 788,00	713,22 863,00	764,46 925,00	753,72 912,00	819,83 992,00	906,60 1 097,00	797,52 965,00	856,19 1 036,00	
EKL 4031E3	Jumta segumiem ar augstumu līdz 16 mm	15-90	651,25 788,00	713,22 863,00	764,46 925,00	753,72 912,00	819,83 992,00	906,60 1 097,00	797,52 965,00	856,19 1 036,00	

Iebūvēšanas komplekts ir saderīgs ar visu veidu VELUX jumta logiem. Jumta logi nav iekļauti, tie jāpasūta atsevišķi. Lai iegūtu vairāk informācijas, lūdzu sazināties ar VELUX klientu servisu.

Cenas bez PVN, Euro
Cenas ar PVN, Euro

		Izmērs (cm)	FK06	FK08	MK04	MK06	MK08	MK10	PK06	PK08	
MINI JUMTA IZBŪVE											
Iebūvēšanas slīpums											
EAW 6000	Mini jumta izbūve, pieslēgums EAW profilētiem jumta segumiem ar profila augstumu līdz 120 mm, viena jumta loga iebūvēšanai mini jumta izbūvē	10-75	628,93 761,00	661,98 801,00	628,93 761,00	661,98 801,00	701,65 849,00	774,38 937,00	747,93 905,00	787,61 953,00	

Cenas bez PVN, Euro
Cenas ar PVN, Euro

		Izmērs (cm)	MK06 78x118	PK06 94x118	SK06 114x118
JUMTA IZBŪVE					
Iebūvēšanas slīpums					
EBW 2022BK	Jumta izbūve, pieslēgums EBW profilētiem jumta segumiem ar profila augstumu līdz 120 mm, kombinētai 4 jumta logu iebūvēšanai jumta izbūvē	35-70	2 528,10 3 059,00	2 842,15 3 439,00	2 895,87 3 504,00
EBW 2032BK	Jumta izbūve, pieslēgums EBW profilētiem jumta segumiem ar profila augstumu līdz 120 mm, kombinētai 6 jumta logu iebūvēšanai jumta izbūvē	35-70	3 013,22 3 646,00	-	-

Mini jumta izbūve un izbūves pieslēgums ļauj VELUX jumta logu iebūvēt, virs jumta līmeņa, tādējādi radot papildu platību no iekšpuses. Jumta izbūves un pieslēgumi perfekti sader ar konkrētā izmēra jumta logu, tādējādi radot ūdensnecaurlaidīgu un labi blīvētu risinājumu.

	MK08	MK10	MK12
	947,92 1 147,00	1 052,89 1 274,00	1 112,39 1 346,00
	947,92 1 147,00	1 052,89 1 274,00	1 112,39 1 346,00
	947,92 1 147,00	1 052,89 1 274,00	-
	947,92 1 147,00	1 052,89 1 274,00	-
	947,92 1 147,00	1 052,89 1 274,00	1 112,39 1 346,00
	947,92 1 147,00	1 052,89 1 274,00	1 112,39 1 346,00

PK10	SK06	SK08	SK10	UK04	UK08	UK10
814,05 985,00	780,99 945,00	827,27 1 001,00	860,33 1 041,00	827,27 1 001,00	893,39 1 081,00	993,39 1 202,00

JUMTA IZBŪVE

Minimālais griestu
augstums (B),
atkarībā no jumta
slīpuma (A)

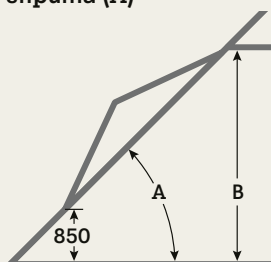

A	min. B mm
35°	2 003
40°	2 171
45°	2 328
50°	2 470
55°	2 600
60°	2 714
65°	2 815
70°	2 900

Pieejamie izmēri

Izmēra kods	Jumta logu kombinācija	Produkta kods
MK06	2×2 jumta logi vai 2×3 jumta logi	EBW MK06 2022BK EBW MK06 2032BK
PK06	2×2 jumta logi	EBW PK06 2022BK
SK06	2×2 jumta logi	EBW SK06 2022BK



Cenas bez PVN, Euro
Cenas ar PVN, Euro

MK31
78x60

MK35
78x95

MK36
78x115

MK38
78x137

PK31
94x60

PK35
94x95

PK36
94x115

PK38
94x137

VERTIKĀLI LOGA ELEMENTI, VERAMI

				W/(m ² K) Iebūvēšanas slīpums								
VFE 3070	Verams ar roku, priedes koks, apstrādāts ar trīskāršu pārklājumu, caurspīdīgs lakojums, vienkameras stikla pakete	1.3	15-55	435,54 527,00	488,43 591,00	519,83 629,00	541,32 655,00	499,17 604,00	552,07 668,00	573,55 694,00	594,21 719,00	
VFE 3068	Verams ar roku, priedes koks, apstrādāts ar trīskāršu pārklājumu, caurspīdīgs lakojums, divkameru stikla pakete	1.1	15-55	543,80 658,00	610,74 739,00	650,41 787,00	676,86 819,00	623,97 755,00	690,08 835,00	716,53 867,00	742,98 899,00	
VFE 3066	Verams ar roku, priedes koks, apstrādāts ar trīskāršu pārklājumu, caurspīdīgs lakojums, divkameru stikla pakete	1.0	15-55	609,09 737,00	683,47 827,00	-	-	698,35 845,00	772,73 935,00	-	-	
VFE 3062	Verams ar roku, priedes koks, apstrādāts ar trīskāršu pārklājumu, caurspīdīgs lakojums, divkameru stikla pakete	1.0	15-55	757,02 916,00	849,59 1 028,00	-	-	867,77 1 050,00	960,33 1 162,00	-	-	
VFA 3070	Verams ar roku, priedes koks, apstrādāts ar trīskāršu pārklājumu, caurspīdīgs lakojums, vienkameras stikla pakete	1.3	15-55	-	563,64 682,00	600,00 726,00	624,79 756,00	-	637,19 771,00	661,16 800,00	685,95 830,00	
VFA 3068	Verams ar roku, priedes koks, apstrādāts ar trīskāršu pārklājumu, caurspīdīgs lakojums, divkameru stikla pakete	1.1	15-55	-	704,13 852,00	750,41 908,00	780,99 945,00	-	795,87 963,00	826,45 1 000,00	857,02 1 037,00	
VFA 3066	Verams ar roku, priedes koks, apstrādāts ar trīskāršu pārklājumu, caurspīdīgs lakojums, divkameru stikla pakete	1.0	15-55	-	788,43 954,00	840,50 1 017,00	874,38 1 058,00	-	891,74 1 079,00	925,62 1 120,00	960,33 1 162,00	
VFB 3070	Verams ar roku, priedes koks, apstrādāts ar trīskāršu pārklājumu, caurspīdīgs lakojums, vienkameras stikla pakete	1.3	15-55	-	563,64 682,00	600,00 726,00	624,79 756,00	-	637,19 771,00	661,16 800,00	685,95 830,00	
VFB 3068	Verams ar roku, priedes koks, apstrādāts ar trīskāršu pārklājumu, caurspīdīgs lakojums, divkameru stikla pakete	1.1	15-55	-	704,13 852,00	750,41 908,00	780,99 945,00	-	795,87 963,00	826,45 1 000,00	857,02 1 037,00	
VFB 3066	Verams ar roku, priedes koks, apstrādāts ar trīskāršu pārklājumu, caurspīdīgs lakojums, divkameru stikla pakete	1.0	15-55	-	788,43 954,00	840,50 1 017,00	874,38 1 058,00	-	891,74 1 079,00	925,62 1 120,00	960,33 1 162,00	

VFE/VFA/VFB vertikālie logi ir paredzēti iebūvēšanai kopā ar jumta logiem GGL/GPL/GLL/GZL vai GIL logu.
VFE/VFA/VFB logu nevar uzstādīt atsevišķi.

	 SK31 114x60	 SK35 114x95	 SK36 114x115	 SK38 114x137	 UK31 134x60	 UK35 134x95	 UK36 134x115	 UK38 134x137
	557,02 674,00	604,96 732,00	615,70 745,00	637,19 771,00	604,96 732,00	657,85 796,00	668,60 809,00	711,57 861,00
	696,69 843,00	756,20 915,00	769,42 931,00	-	756,20 915,00	822,31 995,00	-	-
	780,17 944,00	847,11 1 025,00	-	-	847,11 1 025,00	921,49 1 115,00	-	-
	969,42 1 173,00	1 052,89 1 274,00	-	-	1 052,89 1 274,00	1 145,45 1 386,00	-	-
	-	698,35 845,00	710,74 860,00	734,71 889,00	-	-	-	-
	-	872,73 1 056,00	887,60 1 074,00	919,01 1 112,00	-	-	-	-
	-	977,69 1 183,00	994,21 1 203,00	1 028,93 1 245,00	-	-	-	-
	-	698,35 845,00	710,74 860,00	734,71 889,00	-	-	-	-
	-	872,73 1 056,00	887,60 1 074,00	919,01 1 112,00	-	-	-	-
	-	977,69 1 183,00	994,21 1 203,00	1 028,93 1 245,00	-	-	-	-



Cenas bez PVN, Euro
Cenas ar PVN, Euro



MK31
78x60



MK35
78x95



MK36
78x115



MK38
78x137



PK31
94x60



PK35
94x95



PK36
94x115



PK38
94x137

VERTIKĀLI LOGA ELEMENTI, VERAMI

		W/(m ² K) Iebūvēšanas slīpums											
VFE 2070	Verams ar roku, priedes koks, apstrādāts ar trīskāršu pārklājumu, balti krāsots, vienkameras stikla pakete	1.3	15-55	435,54 527,00	488,43 591,00	519,83 629,00	541,32 655,00	499,17 604,00	552,07 668,00	573,55 694,00	594,21 719,00		
VFE 2068	Verams ar roku, priedes koks, apstrādāts ar trīskāršu pārklājumu, balti krāsots, divkameru stikla pakete	1.1	15-55	543,80 658,00	610,74 739,00	-	-	623,97 755,00	690,08 835,00	-	-		
VFE 2066	Verams ar roku, priedes koks, apstrādāts ar trīskāršu pārklājumu, balti krāsots, divkameru stikla pakete	1.0	15-55	609,09 737,00	683,47 827,00	-	-	698,35 845,00	772,73 935,00	-	-		
VFE 2062	Verams ar roku, priedes koks, apstrādāts ar trīskāršu pārklājumu, balti krāsots, divkameru stikla pakete	1.0	15-55	757,02 916,00	849,59 1 028,00	-	-	867,77 1 050,00	960,33 1 162,00	-	-		
VFA 2070	Verams ar roku, priedes koks, apstrādāts ar trīskāršu pārklājumu, balti krāsots, vienkameras stikla pakete	1.3	15-55	-	563,64 682,00	600,00 726,00	624,79 756,00	-	637,19 771,00	661,16 800,00	685,95 830,00		
VFA 2068	Verams ar roku, priedes koks, apstrādāts ar trīskāršu pārklājumu, balti krāsots, divkameru stikla pakete	1.1	15-55	-	704,13 852,00	750,41 908,00	780,99 945,00	-	795,87 963,00	826,45 1 000,00	857,02 1 037,00		
VFA 2066	Verams ar roku, priedes koks, apstrādāts ar trīskāršu pārklājumu, balti krāsots, divkameru stikla pakete	1.0	15-55	-	788,43 954,00	840,50 1 017,00	874,38 1 058,00	-	891,74 1 079,00	925,62 1 120,00	960,33 1 162,00		
VFB 2070	Verams ar roku, priedes koks, apstrādāts ar trīskāršu pārklājumu, balti krāsots, vienkameras stikla pakete	1.3	15-55	-	563,64 682,00	600,00 726,00	624,79 756,00	-	637,19 771,00	661,16 800,00	685,95 830,00		
VFB 2068	Verams ar roku, priedes koks, apstrādāts ar trīskāršu pārklājumu, balti krāsots, divkameru stikla pakete	1.1	15-55	-	704,13 852,00	750,41 908,00	780,99 945,00	-	795,87 963,00	826,45 1 000,00	857,02 1 037,00		
VFB 2066	Verams ar roku, priedes koks, apstrādāts ar trīskāršu pārklājumu, balti krāsots, divkameru stikla pakete	1.0	15-55	-	788,43 954,00	840,50 1 017,00	874,38 1 058,00	-	891,74 1 079,00	925,62 1 120,00	960,33 1 162,00		

VFE/VFA/VFB vertikālie loga elementi ir paredzēti iebūvēšanai kopā ar jumta logiem GGL/GPL/GLL/GZL vai GIL logu. VFE/VFA/VFB logu nevar iebūvēt atsevišķi.



Cenas bez PVN, Euro
Cenas ar PVN, Euro



MK31
78x60



MK35
78x95



MK36
78x115



MK38
78x137



PK31
94x60



PK35
94x95



PK36
94x115











PK38
94x137





VERTIKĀLI LOGA ELEMENTI, NEVERAMI

		W/(m ² K) Iebūvēšanas slīpums											
VIU 0070	Neverams, balts poliuretāns ap koka kodolu ar papildu izturīgu pārklājumu, vienkameras stikla pakete	1.3	15-55	378,51 458,00	424,79 514,00	452,07 547,00	470,25 569,00	433,88 525,00	480,17 581,00	498,35 603,00	516,53 625,00		
VIU 0068	Neverams, balts poliuretāns ap koka kodolu ar papildu izturīgu pārklājumu, divkameru stikla pakete	1.1	15-55	472,73 572,00	530,58 642,00	-	-	542,15 656,00	600,00 726,00	-	-		
VIU 0066	Neverams, balts poliuretāns ap koka kodolu ar papildu izturīgu pārklājumu, divkameru stikla pakete	1.0	15-55	529,75 641,00	594,21 719,00	-	-	607,44 735,00	671,90 813,00	-	-		
VIU 0062	Neverams, balts poliuretāns ap koka kodolu ar papildu izturīgu pārklājumu, divkameru stikla pakete	1.0	15-55	657,85 796,00	738,84 894,00	-	-	754,55 913,00	834,71 1 010,00	-	-		

VIU vertikālie loga elementi ir paredzēti iebūvēšanai zem GGU/GLU/GPU jumta loga, VIU logu nevar uzstādīt atsevišķi.

							
SK31 114x60	SK35 114x95	SK36 114x115	SK38 114x137	UK31 134x60	UK35 134x95	UK36 134x115	UK38 134x137

557,02 674,00	604,96 732,00	615,70 745,00	637,19 771,00	604,96 732,00	657,85 796,00	668,60 809,00	711,57 861,00
696,69 843,00	756,20 915,00	-	-	756,20 915,00	822,31 995,00	-	-
780,17 944,00	847,11 1 025,00	-	-	847,11 1 025,00	921,49 1 115,00	-	-
969,42 1 173,00	1 052,89 1 274,00	-	-	1 052,89 1 274,00	1 145,45 1 386,00	-	-
-	698,35 845,00	710,74 860,00	734,71 889,00	-	-	-	-
-	872,73 1 056,00	887,60 1 074,00	919,01 1 112,00	-	-	-	-
-	977,69 1 183,00	994,21 1 203,00	1 028,93 1 245,00	-	-	-	-
-	698,35 845,00	710,74 860,00	734,71 889,00	-	-	-	-
-	872,73 1 056,00	887,60 1 074,00	919,01 1 112,00	-	-	-	-
-	977,69 1 183,00	994,21 1 203,00	1 028,93 1 245,00	-	-	-	-

			
SK31 114x60	SK35 114x95	SK36 114x115	SK38 114x137

484,30 586,00	525,62 636,00	535,54 648,00	553,72 670,00
605,79 733,00	657,02 795,00	-	-
678,51 821,00	736,36 891,00	-	-
842,98 1 020,00	914,88 1 107,00	-	-

Cenas bez PVN, Euro
Cenas ar PVN, Euro

Izmērs (cm)

MK00
78x+++

PK00
94x+++

SK00
114x+++

FASĀDES ELEMENTA SAVIENOJUMS EFY TIEK LIETOTS, LAI SAVIENOTU VELUX JUMTA LOGU AR JEBKURU FASĀDES ELEMENTU, PIEMĒRAM, AR LOGU VAI DURVĪM. ELEMENTAM JĀBŪT VIENĀ PLATUMĀ AR EFY.

Iebūvēšanas
slīpums

EFY 2012	-	129,75 157,00	136,36 165,00	141,32 171,00
EFY 3012	-	129,75 157,00	136,36 165,00	141,32 171,00

Cenas bez PVN, Euro
Cenas ar PVN, Euro

Izmērs (cm)

MK04
78x98

MK06
78x118

MK08
78x140

MK10
78x160

MK12
78x180

PK06
94x118

PK08
94x140

PK10
94x160

JUMTA LOGU UN VERTIKĀLO LOGA ELEMENTU KOMBINĀCIJAS VFE, VFA, VFB VAI VIU VIENA LOGA IEBŪVĒŠANA KOMBINĀCIJĀ AR VERTIKĀLO LOGA ELEMENTU

Iebūvēšanas
slīpums

Standarta iebūvēšanas līmenis (sarkanais līmenis)

EFW 0012	Profilētiem jumta segumiem ar profila augstumu līdz 120 mm	15-55	139,67 169,00	147,11 178,00	156,20 189,00	171,90 208,00	175,21 212,00	166,12 201,00	184,30 223,00	180,99 219,00
EFS 0012	Plakaniem jumta segumiem ar augstumu līdz 16 mm (2 x 8 mm)	15-55	139,67 169,00	147,11 178,00	156,20 189,00	171,90 208,00	-	166,12 201,00	184,30 223,00	180,99 219,00

Padziļināts iebūvēšanas līmenis 40 mm dziļāk jumta konstrukcijā (zilais līmenis)

EFJ 0012	Plakaniem vai profilētiem jumta segumiem ar augstumu līdz 90 mm	20-55	139,67 169,00	147,11 178,00	156,20 189,00	171,90 208,00	175,21 212,00	166,12 201,00	184,30 223,00	180,99 219,00
EFN 0012	Plakaniem jumta segumiem ar augstumu līdz 16 mm (2 x 8 mm)	20-55	139,67 169,00	147,11 178,00	156,20 189,00	-	175,21 212,00	166,12 201,00	184,30 223,00	180,99 219,00

KOMBINĒTAJAI IEBŪVĒŠANAI AR VERTIKĀLIEM LOGA ELEMENTIEM

Standarta iebūvēšanas līmenis (sarkanais līmenis)

EFW 0022E	Profilētiem jumta segumiem ar profila augstumu līdz 120 mm	15-55	345,45 418,00	352,89 427,00	361,98 438,00	377,69 457,00	380,99 461,00	371,90 450,00	390,08 472,00	386,78 468,00
EFS 0022E	Plakaniem jumta segumiem ar augstumu līdz 16 mm (2 x 8 mm)	15-55	345,45 418,00	352,89 427,00	361,98 438,00	377,69 457,00	380,99 461,00	371,90 450,00	390,08 472,00	386,78 468,00

Padziļināts iebūvēšanas līmenis 40 mm dziļāk jumta konstrukcijā (zilais līmenis)

EFJ 0022E	Plakaniem vai profilētiem jumta segumiem ar augstumu līdz 90 mm	20-55	345,45 418,00	352,89 427,00	361,98 438,00	377,69 457,00	380,99 461,00	371,90 450,00	390,08 472,00	386,78 468,00
EFN 0022E	Plakaniem jumta segumiem ar augstumu līdz 16 mm (2 x 8 mm)	20-55	345,45 418,00	352,89 427,00	361,98 438,00	-	-	371,90 450,00	390,08 472,00	386,78 468,00

TRĪS LOGU KOMBINĀCIJAI AR VERTIKĀLIEM LOGA ELEMENTIEM

Standarta iebūvēšanas līmenis (sarkanais līmenis)

EFW 0032B	Profilētiem jumta segumiem ar profila augstumu līdz 120 mm	15-55	345,45 418,00	352,89 427,00	361,98 438,00	377,69 457,00	380,99 461,00	-	-	-
EFW 0032C	Profilētiem jumta segumiem ar profila augstumu līdz 120 mm	15-55	345,45 418,00	352,89 427,00	361,98 438,00	377,69 457,00	380,99 461,00	-	-	-
EFW 0032E	Profilētiem jumta segumiem ar profila augstumu līdz 120 mm	15-55	345,45 418,00	352,89 427,00	361,98 438,00	377,69 457,00	380,99 461,00	-	-	-
EFS 0032B	Plakaniem jumta segumiem ar augstumu līdz 16 mm (2 x 8 mm)	15-55	345,45 418,00	352,89 427,00	361,98 438,00	377,69 457,00	380,99 461,00	-	-	-
EFS 0032C	Plakaniem jumta segumiem ar augstumu līdz 16 mm (2 x 8 mm)	15-55	345,45 418,00	352,89 427,00	361,98 438,00	377,69 457,00	380,99 461,00	-	-	-
EFS 0032E	Plakaniem jumta segumiem ar augstumu līdz 16 mm (2 x 8 mm)	15-55	345,45 418,00	352,89 427,00	361,98 438,00	377,69 457,00	380,99 461,00	-	-	-

Padziļināts iebūvēšanas līmenis 40 mm dziļāk jumta konstrukcijā (zilais līmenis)

EFJ 0032E	Plakaniem vai profilētiem jumta segumiem ar augstumu līdz 90 mm	20-55	345,45 418,00	352,89 427,00	361,98 438,00	377,69 457,00	380,99 461,00	-	-	-
EFN 0032E	Plakaniem jumta segumiem ar augstumu līdz 16 mm (2 x 8 mm)	20-55	345,45 418,00	352,89 427,00	361,98 438,00	-	-	-	-	-



Cenas bez PVN, Euro
Cenas ar PVN, Euro

MK34 78x92	PK34 94x92	SK34 114x92

Cenas bez PVN, Euro
Cenas ar PVN, Euro

Izmērs (cm)

WK34
+++x94

NEVERAMS LOGA ELEMENTS

		W/(m² K)		Iebūvēšanas slīpums		
GIL 3070	Neverams, priedes koks, apstrādāts ar trīskāršu pārklājumu, caurspīdīgs lakojums, vienkameras stikla pakete	1.3	15-90	367,77 445,00	416,53 504,00	457,02 553,00
GIL 3068	Neverams, priedes koks, apstrādāts ar trīskāršu pārklājumu, caurspīdīgs lakojums, divkameru stikla pakete	1.1	15-90	459,50 556,00	520,66 630,00	571,90 692,00
GIL 3066	Neverams, priedes koks, apstrādāts ar trīskāršu pārklājumu, caurspīdīgs lakojums, divkameru stikla pakete	1.0	15-90	514,05 622,00	582,64 705,00	640,50 775,00
GIU 0070	Neverams, balts poliuretāns ap koka kodolu ar papildu izturīgu pārklājumu, vienkameras stikla pakete	1.3	15-90	414,88 502,00	470,25 569,00	516,53 625,00
GIU 0068	Neverams, balts poliuretāns ap koka kodolu ar papildu izturīgu pārklājumu, divkameru stikla pakete	1.1	15-90	519,01 628,00	588,43 712,00	646,28 782,00
GIU 0066	Neverams, balts poliuretāns ap koka kodolu ar papildu izturīgu pārklājumu, divkameru stikla pakete	1.0	15-90	580,99 703,00	658,68 797,00	723,14 875,00
GIU 0062	Neverams, balts poliuretāns ap koka kodolu ar papildu izturīgu pārklājumu, divkameru stikla pakete	1.0	15-90	722,31 874,00	819,01 991,00	899,17 1 088,00
GIL 2070	Neverams, priedes koks, apstrādāts ar trīskāršu pārklājumu, balti krāsots, vienkameras stikla pakete	1.3	15-90	367,77 445,00	416,53 504,00	457,02 553,00
GIL 2068	Neverams, priedes koks, apstrādāts ar trīskāršu pārklājumu, balti krāsots, divkameru stikla pakete	1.1	15-90	459,50 556,00	520,66 630,00	571,90 692,00
GIL 2066	Neverams, priedes koks, apstrādāts ar trīskāršu pārklājumu, balti krāsots, divkameru stikla pakete	1.0	15-90	514,05 622,00	582,64 705,00	640,50 775,00
GIL 2062	Neverams, priedes koks, apstrādāts ar trīskāršu pārklājumu, balti krāsots, divkameru stikla pakete	1.0	15-90	639,67 774,00	724,79 877,00	795,87 963,00

GIU slīpie loga elementi (loga pagarinājumi) ir paredzēti iebūvēšanai zem GGL, GPL un GLL jumta logiem. Logi tiek iebūvēti tieši zem augšējā loga rāmja, neizmantojot papildu profilus. GIL logu nevar iebūvēt atsevišķi. GIL logs ir neverams.

GIU slīpie loga elementi (loga pagarinājumi) ir paredzēti iebūvēšanai zem GGU, GPU un GLU jumta loga. Logi tiek iebūvēti tieši zem augšējā loga rāmja, neizmantojot papildus profilus. GIU logu nevar iebūvēt atsevišķi. GIU logs ir neverams.

JUMTA LOGS KOMBINĀCIJĀ AR NEVERAMO LOGA ELEMENTU GIL VAI GIU

Viena loga iebūvēšanai kombinācijā ar neveramo loga elementu

		Iebūvēšanas slīpums	
Standarta iebūvēšanas līmenis (sarkanais līmenis)			
ETW 1000	Profilētiem jumta segumiem ar profila augstumu līdz 120 mm	15-90	100,83 122,00
ETW 1000S	Profilētiem jumta segumiem ar profila augstumu līdz 120 mm	15-90	100,83 122,00
ETW 2000	Profilētiem jumta segumiem ar profila augstumu līdz 120 mm	15-90	114,88 139,00
ETW 2000S	Profilētiem jumta segumiem ar profila augstumu līdz 120 mm	15-90	114,88 139,00
ETS 1000	Plakaniem jumta segumiem ar augstumu līdz 16 mm (2 x 8 mm)	15-90	100,83 122,00
ETS 2000	Plakaniem jumta segumiem ar augstumu līdz 16 mm (2 x 8 mm)	15-90	114,88 139,00

Padziļināts iebūvēšanas līmenis 40 mm dziļāk jumta konstrukcijā (zilais līmenis)

ETJ 1000	Plakaniem vai profilētiem jumta segumiem ar augstumu līdz 90 mm	20-90	-
ETJ 2000	Plakaniem vai profilētiem jumta segumiem ar augstumu līdz 90 mm	20-90	-

Cenas bez PVN, Euro
Cenas ar PVN, Euro

Izmērs (cm)

WK34
+++x94

KOMBINĒTAJAI IEBŪVĒŠANAI AR NEVERAMAJIEM LOGA ELEMENTIEM

		Iebūvēšanas slīpums	
Standarta iebūvēšanas līmenis (sarkanais līmenis)			
ETW 2000M (F, G, H)*	Profilētiem jumta segumiem ar profila augstumu līdz 120 mm	15-90	114,88 139,00
ETS 2000M (F, G, H)*	Plakaniem jumta segumiem ar augstumu līdz 16 mm (2 x 8 mm)	15-90	114,88 139,00
Padziļināts iebūvēšanas līmenis 40 mm dziļāk jumta konstrukcijā (zilais līmenis)			
ETJ 2000M (F, G, H)*	Plakaniem vai profilētiem jumta segumiem ar augstumu līdz 90 mm	20-90	-



Cenas bez PVN, Euro
Cenas ar PVN, Euro

MK19

PK19

SK19

JUMTA BALKONS

		W/(m ² K)		Iebūvēšanas slīpums		
GDL 2066	Verams ar roku, rokturis apakšā, pa augšējo asi verams, priedes koks, apstrādāts ar trīskāršu pārklājumu, balti krāsots, divkameru stikla pakete	1.3	35-53	2 205,79 2 669,00	-	-
GDL 3066	Verams ar roku, rokturis apakšā, pa augšējo asi verams, priedes koks, apstrādāts ar trīskāršu pārklājumu, caurspīdīgs lakojums, divkameru stikla pakete	1.3	35-53	2 205,79 2 669,00	-	-
GDL 2066	Verams ar roku, rokturis apakšā, pa augšējo asi verams, priedes koks, apstrādāts ar trīskāršu pārklājumu, balti krāsots, divkameru stikla pakete	1.1	35-53	-	2 371,90 2 870,00	-
GDL 3066	Verams ar roku, rokturis apakšā, pa augšējo asi verams, priedes koks, apstrādāts ar trīskāršu pārklājumu, caurspīdīgs lakojums, divkameru stikla pakete	1.1	35-53	-	2 371,90 2 870,00	-
GDL 2066	Verams ar roku, rokturis apakšā, pa augšējo asi verams, priedes koks, apstrādāts ar trīskāršu pārklājumu, balti krāsots, divkameru stikla pakete	1.1	35-53	-	-	2 538,02 3 071,00
GDL 3066	Verams ar roku, rokturis apakšā, pa augšējo asi verams, priedes koks, apstrādāts ar trīskāršu pārklājumu, caurspīdīgs lakojums, divkameru stikla pakete	1.1	35-53	-	-	2 538,02 3 071,00

GDL logam MK19 izmērā $U_w = 1,3$

GDL balkona loga augšējā vārtne tiek darbināta ar apakšējo rokturi, apakšējā vārtne ar rokturu pāri. Logs ir aprīkots ar vidējo enģi, kas ļauj pagriezt vārtņi ērtākai tās tīrīšanai.

Cenas bez PVN, Euro
Cenas ar PVN, Euro

Izmērs (cm)

MK19
78x252

PK19
94x252

SK19
114x252

JUMTA BALKONA IEBŪVĒŠANA

Hidroizolācijas risinājums 1000 ietver difūzijas membrānu BFX un drenāžas noteku

		Iebūvēšanas slīpums			
EDW 1000	Profīlētiem jumta segumiem ar profila augstumu līdz 120 mm	35-53	147,11 178,00	176,03 213,00	163,64 198,00
EDS 1000	Plakaniem jumta segumiem ar augstumu līdz 16 mm (2 x 8 mm)	35-53	147,11 178,00	176,03 213,00	163,64 198,00
EDL 1000	Jumta segumiem ar augstumu līdz 16 mm	35-53	147,11 178,00	176,03 213,00	163,64 198,00

Cenas bez PVN, Euro
Cenas ar PVN, Euro

Izmērs (cm)

MK19
78x252

PK19
94x252

SK19
114x252

HIDRO UN SILTUMIZOLĀCIJAS RISINĀJUMS 2000 IETVER DIFŪZIJAS MEMBRĀNU BFX, DRENĀŽAS NOTEKU UN SILTUMIZOLĀCIJAS RĀMI BDX

		Iebūvēšanas slīpums			
EDW 2000	Profīlētiem jumta segumiem ar profila augstumu līdz 120 mm	35-53	171,07 207,00	204,96 248,00	190,08 230,00
EDS 2000	Plakaniem jumta segumiem ar augstumu līdz 16 mm (2 x 8 mm)	35-53	171,07 207,00	204,96 248,00	190,08 230,00
EDL 2000	Jumta segumiem ar augstumu līdz 16 mm	35-53	-	204,96 248,00	-

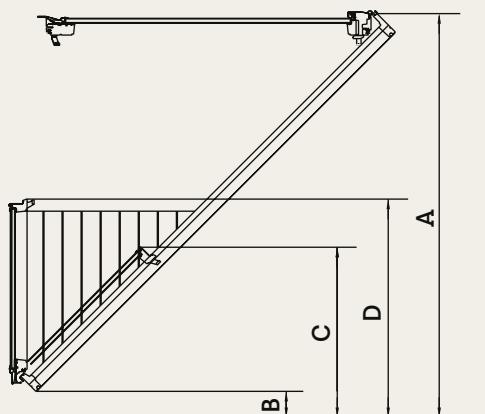

	A	B	C	D
Jumta slīpums	Loga augša	Loga apakša	Augša apakšējam balkona elementam	Margu augstums
	cm	cm	cm	cm
53°	209	0	81	95
50°	201	0	79	95
45°	200	13	88	108
40°	200	28	98	123
35°	200	45	109	140

Jumta slīpuma ietekme uz loga apakšējās malas un loga margas augstumu.



Cenas bez PVN, Euro
Cenas ar PVN, Euro

M08
78x140

M35
78x109

JUMTA TERASE

		W/(m² K)		Iebūvēšanas slīpums			
GEL 2065	Atverams uz āru, priedes koks, apstrādāts ar trīskāršu pārklājumu, balti krāsots, divkameru stikla pakete	1.0	35-53	1 201,65 1 454,00	-		
GEL 3065	Atverams uz āru, priedes koks, apstrādāts ar trīskāršu pārklājumu, caurspīdīgs lakojums, divkameru stikla pakete	1.0	35-53	1 201,65 1 454,00	-		
VEA 2065	Atverams uz āru pa labi, priedes koks, apstrādāts ar trīskāršu pārklājumu, balti krāsots, divkameru stikla pakete	1.0	35-53	-	1 014,05 1 227,00		
VEA 3065	Atverams uz āru pa labi, priedes koks, apstrādāts ar trīskāršu pārklājumu, caurspīdīgs lakojums, divkameru stikla pakete	1.0	35-53	-	1 014,05 1 227,00		
VEB 2065	Atverams uz āru pa kreisi, priedes koks, apstrādāts ar trīskāršu pārklājumu, balti krāsots, divkameru stikla pakete	1.0	35-53	-	1 014,05 1 227,00		
VEB 3065	Atverams uz āru pa kreisi, priedes koks, apstrādāts ar trīskāršu pārklājumu, caurspīdīgs lakojums, divkameru stikla pakete	1.0	35-53	-	1 014,05 1 227,00		
VEC 2065	Neverams, priedes koks, apstrādāts ar trīskāršu pārklājumu, balti krāsots, divkameru stikla pakete	1.0	35-53	-	1 014,05 1 227,00		
VEC 3065	Neverams, priedes koks, apstrādāts ar trīskāršu pārklājumu, caurspīdīgs lakojums, divkameru stikla pakete	1.0	35-53	-	1 014,05 1 227,00		

GEL ir slīpā jumta logs, kas apvienots ar vertikālu loga elementu VEA/B (atveramu) vai VEC (fiksētu). Apvienojot vairākus logus šādā kombinācijā, atvērt varēs tikai vienu.

Terases izmērs, atkarībā no jumta slīpuma

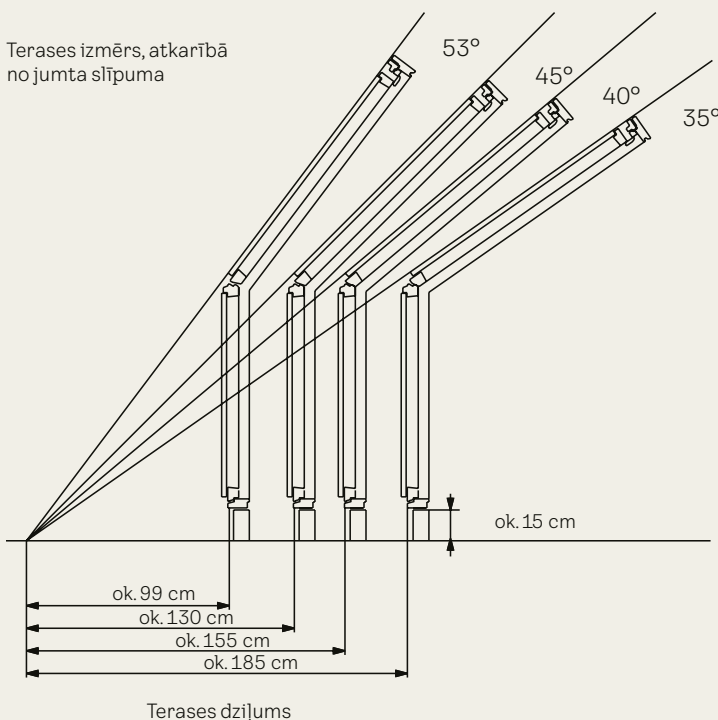

Cenas bez PVN, Euro
Cenas ar PVN, Euro

Izmērs (cm)

M08
78x140

M35
78x109

JUMTA TERASES KOMBINĀCIJA

Jumta terases iebūvēšana

		Iebūvēšanas slīpums			
EEW 0000	Profilētiem jumta segumiem ar profila augstumu līdz 120 mm	35-53	157,85 191,00	-	
EES 0000	Plakaniem jumta segumiem ar augstumu līdz 16 mm (2 x 8 mm)	35-53	116,53 141,00	-	
EEX 0000	Vējmalas apdares balsts jumta terasei	35-53	-	184,30 223,00	

Cenas bez PVN, Euro
Cenas ar PVN, Euro

Izmērs (cm)

M08
78x140

KOMBINĒTĀ JUMTA TERASES IEBŪVĒŠANA

		Iebūvēšanas slīpums			
EEW 0001E	Profilētiem jumta segumiem ar profila augstumu līdz 120 mm	35-53	157,85 191,00		
EEW 0002E	Profilētiem jumta segumiem ar profila augstumu līdz 120 mm	35-53	157,85 191,00		
EEW 0003	Profilētiem jumta segumiem ar profila augstumu līdz 120 mm	35-53	157,85 191,00		
EES 0001E	Plakaniem jumta segumiem ar augstumu līdz 16 mm (2 x 8 mm)	35-53	116,53 141,00		
EES 0002E	Plakaniem jumta segumiem ar augstumu līdz 16 mm (2 x 8 mm)	35-53	116,53 141,00		
EES 0003	Plakaniem jumta segumiem ar augstumu līdz 16 mm (2 x 8 mm)	35-53	116,53 141,00		

Nav iespējams blakus uzstādīt divas jumta terases apakšējās daļas ar durvju funkciju. VEA/VEB elementi obligāti jāiebūvē jumta konstrukcijas spārēs.



Cenas bez PVN, Eiro
Cenas ar PVN, Eiro

FFKF06
188x118

FFKF08
188x140

JUMTA LOGI TRĪS VIENĀ

		W/(m ² K) Iebūvēšanas slīpums			
GGLS 2066	Verams ar roku, rokturis augšā, priedes koks, apstrādāts ar trīskāršu pārklājumu, balti krāsots, divkameru stikla pakete	1.0-1.1	15-90	1 374,38 1 663,00	1 607,44 1 945,00
GGLS 206630	Solārs, priedes koks, apstrādāts ar trīskāršu pārklājumu, balti krāsots, divkameru stikla pakete	1.0-1.1	15-90	2 126,45 2 573,00	2 359,50 2 855,00
GGLS 2070	Verams ar roku, rokturis augšā, priedes koks, apstrādāts ar trīskāršu pārklājumu, balti krāsots, vienkameru stikla pakete	1.3-1.4	15-90	981,82 1 188,00	1 147,93 1 389,00
GGLS 207030	Solārs, priedes koks, apstrādāts ar trīskāršu pārklājumu, balti krāsots, vienkameru stikla pakete	1.3-1.4	15-90	1 733,88 2 098,00	1 900,00 2 299,00
GPLS 2066	Verams ar roku, rokturis apakšā, pa augšējo asi verams, priedes koks, apstrādāts ar trīskāršu pārklājumu, balti krāsots, divkameru stikla pakete	1.1-1.2	15-55	1 774,38 2 147,00	2 007,44 2 429,00
GPLS 2070	Verams ar roku, rokturis apakšā, pa augšējo asi verams, priedes koks, apstrādāts ar trīskāršu pārklājumu, balti krāsots, vienkameru stikla pakete	1.3-1.4	15-55	1 381,82 1 672,00	1 547,93 1 873,00

EDWS un EDLS pieslēgumos ietilpst arī izolācijas rāmis BDX un difūzijas membrāna BFX.

Cenas bez PVN, Eiro
Cenas ar PVN, Eiro

FFKF06
188x118

FFKF08
188x140

PIESLĒGUMS AR BDX JUMTA LOGIEM TRĪS VIENĀ

		Iebūvēšanas slīpums			
EDWS 2000		15-90		1 214,63 1 494,00	1 291,87 1 589,00
EDLS 2000		15-90		1 214,63 1 494,00	1 291,87 1 589,00

EDWS un EDLS pieslēgumos ietilpst arī izolācijas rāmis BDX un difūzijas membrāna BFX.

PRODUKTU KOMPLEKTI

Cenas bez PVN, Euro
Cenas ar PVN, Euro

2 x CK04
2 x 55x98

2 x FK06
2 x 66x118

2 x FK08
2 x 66x140

2 x MK04
2 x 78x98









2 x MK06
2 x 78x118

2 x MK08
2 x 78x140

2 x MK10
2 x 78x160

2 x PK08
2 x 94x140







KOMBINĒTIE RISINĀJUMI									
2 x GLL 1061B + EKS 2021M	GLL S10S84	783,47 948,00	910,74 1 102,00	993,39 1 202,00	895,87 1 084,00	970,25 1 174,00	1 041,32 1 260,00	1 200,00 1 452,00	1 214,88 1 470,00
2 x GLL 1061 + EKS 2021M	GLL S10S85	783,47 948,00	910,74 1 102,00	993,39 1 202,00	895,87 1 084,00	970,25 1 174,00	1 041,32 1 260,00	1 200,00 1 452,00	1 214,88 1 470,00
2 x GLL 1064B + EKS 2021M	GLL S10S86	935,54 1 132,00	1 087,60 1 316,00	1 186,78 1 436,00	1 067,77 1 292,00	1 158,68 1 402,00	1 242,98 1 504,00	1 433,06 1 734,00	1 449,59 1 754,00
2 x GLL 1064 + EKS 2021M	GLL S10S87	935,54 1 132,00	1 087,60 1 316,00	1 186,78 1 436,00	1 067,77 1 292,00	1 158,68 1 402,00	1 242,98 1 504,00	1 433,06 1 734,00	1 449,59 1 754,00
2 x GLL 1061 + EKT 0003 + EKT 0001E	GLL S10T07	709,09 858,00	828,10 1 002,00	905,79 1 096,00	813,22 984,00	882,64 1 068,00	947,11 1 146,00	1 097,52 1 328,00	1 109,09 1 342,00
2 x GLL 1064 + EKT 0003 + EKT 0001E	GLL S10T08	861,16 1 042,00	1 004,96 1 216,00	1 099,17 1 330,00	985,12 1 192,00	1 071,07 1 296,00	1 148,76 1 390,00	1 330,58 1 610,00	1 343,80 1 626,00
2 x GLL 1061 + EKT 0003 + EKT 0001F	GLL S10T09	709,09 858,00	828,10 1 002,00	905,79 1 096,00	813,22 984,00	882,64 1 068,00	947,11 1 146,00	1 097,52 1 328,00	1 109,09 1 342,00
2 x GLL 1064 + EKT 0003 + EKT 0001F	GLL S10T10	861,16 1 042,00	1 004,96 1 216,00	1 099,17 1 330,00	985,12 1 192,00	1 071,07 1 296,00	1 148,76 1 390,00	1 330,58 1 610,00	1 343,80 1 626,00
2 x GLL 1061 + EKT 0003 + EKT 0001G	GLL S10T11	709,09 858,00	828,10 1 002,00	905,79 1 096,00	813,22 984,00	882,64 1 068,00	947,11 1 146,00	1 097,52 1 328,00	1 109,09 1 342,00
2 x GLL 1064 + EKT 0003 + EKT 0001G	GLL S10T12	861,16 1 042,00	1 004,96 1 216,00	1 099,17 1 330,00	985,12 1 192,00	1 071,07 1 296,00	1 148,76 1 390,00	1 330,58 1 610,00	1 343,80 1 626,00
2 x GLL 1061 + EKT 0003 + EKT 0001H	GLL S10T13	709,09 858,00	828,10 1 002,00	905,79 1 096,00	813,22 984,00	882,64 1 068,00	947,11 1 146,00	1 097,52 1 328,00	1 109,09 1 342,00
2 x GLL 1064B + EKT 0003 + EKT 0001E	GLL S10T15	861,16 1 042,00	1 004,96 1 216,00	1 099,17 1 330,00	985,12 1 192,00	1 071,07 1 296,00	1 148,76 1 390,00	1 330,58 1 610,00	1 343,80 1 626,00
2 x GLL 1064B + EKT 0003 + EKT 0001F	GLL S10T16	861,16 1 042,00	1 004,96 1 216,00	1 099,17 1 330,00	985,12 1 192,00	1 071,07 1 296,00	1 148,76 1 390,00	1 330,58 1 610,00	1 343,80 1 626,00
2 x GLL 1064B + EKT 0003 + EKT 0001G	GLL S10T17	861,16 1 042,00	1 004,96 1 216,00	1 099,17 1 330,00	985,12 1 192,00	1 071,07 1 296,00	1 148,76 1 390,00	1 330,58 1 610,00	1 343,80 1 626,00
2 x GLL 1064B + EKT 0003 + EKT 0001H	GLL S10T18	861,16 1 042,00	1 004,96 1 216,00	1 099,17 1 330,00	985,12 1 192,00	1 071,07 1 296,00	1 148,76 1 390,00	1 330,58 1 610,00	1 343,80 1 626,00
2 x GLL 1064 + EKT 0003 + EKT 0001H	GLL S10T19	861,16 1 042,00	1 004,96 1 216,00	1 099,17 1 330,00	985,12 1 192,00	1 071,07 1 296,00	1 148,76 1 390,00	1 330,58 1 610,00	1 343,80 1 626,00
2 x GLL 1061B + EKT 0003 + EKT 0001H	GLL S10T21	709,09 858,00	828,10 1 002,00	905,79 1 096,00	813,22 984,00	882,64 1 068,00	947,11 1 146,00	1 097,52 1 328,00	1 109,09 1 342,00
2 x GLL 1061B + EKW 2021M	GLL S10W75	783,47 948,00	910,74 1 102,00	993,39 1 202,00	895,87 1 084,00	970,25 1 174,00	1 041,32 1 260,00	1 200,00 1 452,00	1 214,88 1 470,00
2 x GLL 1061 + EKW 2021M	GLL S10W76	783,47 948,00	910,74 1 102,00	993,39 1 202,00	895,87 1 084,00	970,25 1 174,00	1 041,32 1 260,00	1 200,00 1 452,00	1 214,88 1 470,00
2 x GLL 1064B + EKW 2021M	GLL S10W77	935,54 1 132,00	1 087,60 1 316,00	1 186,78 1 436,00	1 067,77 1 292,00	1 158,68 1 402,00	1 242,98 1 504,00	1 433,06 1 734,00	1 449,59 1 754,00
2 x GLL 1064 + EKW 2021M	GLL S10W78	935,54 1 132,00	1 087,60 1 316,00	1 186,78 1 436,00	1 067,77 1 292,00	1 158,68 1 402,00	1 242,98 1 504,00	1 433,06 1 734,00	1 449,59 1 754,00
2 x GLU 0061B + EKS 2021M	GLU S10S80	935,54 1 132,00	1 087,60 1 316,00	1 186,78 1 436,00	1 067,77 1 292,00	1 158,68 1 402,00	1 242,98 1 504,00	1 433,06 1 734,00	1 449,59 1 754,00
2 x GLU 0061 + EKS 2021M	GLU S10S81	935,54 1 132,00	1 087,60 1 316,00	1 186,78 1 436,00	1 067,77 1 292,00	1 158,68 1 402,00	1 242,98 1 504,00	1 433,06 1 734,00	1 449,59 1 754,00
2 x GLU 0064B + EKS 2021M	GLU S10S82	1 123,97 1 360,00	1 305,79 1 580,00	1 426,45 1 726,00	1 282,64 1 552,00	1 391,74 1 684,00	1 490,91 1 804,00	1 722,31 2 084,00	1 740,50 2 106,00
2 x GLU 0064 + EKS 2021M	GLU S10S83	1 123,97 1 360,00	1 305,79 1 580,00	1 426,45 1 726,00	1 282,64 1 552,00	1 391,74 1 684,00	1 490,91 1 804,00	1 722,31 2 084,00	1 740,50 2 106,00
2 x GLU 0061 + EKT 0003 + EKT 0001E	GLU S10T07	861,16 1 042,00	1 004,96 1 216,00	1 099,17 1 330,00	985,12 1 192,00	1 071,07 1 296,00	1 148,76 1 390,00	1 330,58 1 610,00	1 343,80 1 626,00
2 x GLU 0064 + EKT 0003 + EKT 0001E	GLU S10T08	1 049,59 1 270,00	1 223,14 1 480,00	1 338,84 1 620,00	1 200,00 1 452,00	1 304,13 1 578,00	1 396,69 1 690,00	1 619,83 1 960,00	1 634,71 1 978,00

 2 x CK04 2 x 55x98	 2 x FK06 2 x 66x118	 2 x FK08 2 x 66x140	 2 x MK04 2 x 78x98	 2 x MK06 2 x 78x118	 2 x MK08 2 x 78x140	 2 x MK10 2 x 78x160	 2 x PK08 2 x 94x140
--	---	---	--	---	---	---	---

KOMBINĒTIE RISINĀJUMI									
2 x GLU 0061 + EKT 0003 + EKT 0001F	GLU S10T09	861,16 1 042,00	1 004,96 1 216,00	1 099,17 1 330,00	985,12 1 192,00	1 071,07 1 296,00	1 148,76 1 390,00	1 330,58 1 610,00	1 343,80 1 626,00
2 x GLU 0064 + EKT 0003 + EKT 0001F	GLU S10T10	1 049,59 1 270,00	1 223,14 1 480,00	1 338,84 1 620,00	1 200,00 1 452,00	1 304,13 1 578,00	1 396,69 1 690,00	1 619,83 1 960,00	1 634,71 1 978,00
2 x GLU 0061 + EKT 0003 + EKT 0001G	GLU S10T11	861,16 1 042,00	1 004,96 1 216,00	1 099,17 1 330,00	985,12 1 192,00	1 071,07 1 296,00	1 148,76 1 390,00	1 330,58 1 610,00	1 343,80 1 626,00
2 x GLU 0064 + EKT 0003 + EKT 0001G	GLU S10T12	1 049,59 1 270,00	1 223,14 1 480,00	1 338,84 1 620,00	1 200,00 1 452,00	1 304,13 1 578,00	1 396,69 1 690,00	1 619,83 1 960,00	1 634,71 1 978,00
2 x GLU 0061 + EKT 0003 + EKT 0001H	GLU S10T13	861,16 1 042,00	1 004,96 1 216,00	1 099,17 1 330,00	985,12 1 192,00	1 071,07 1 296,00	1 148,76 1 390,00	1 330,58 1 610,00	1 343,80 1 626,00
2 x GLU 0064B + EKT 0003 + EKT 0001E	GLU S10T15	1 049,59 1 270,00	1 223,14 1 480,00	1 338,84 1 620,00	1 200,00 1 452,00	1 304,13 1 578,00	1 396,69 1 690,00	1 619,83 1 960,00	1 634,71 1 978,00
2 x GLU 0064B + EKT 0003 + EKT 0001F	GLU S10T16	1 049,59 1 270,00	1 223,14 1 480,00	1 338,84 1 620,00	1 200,00 1 452,00	1 304,13 1 578,00	1 396,69 1 690,00	1 619,83 1 960,00	1 634,71 1 978,00
2 x GLU 0064B + EKT 0003 + EKT 0001G	GLU S10T17	1 049,59 1 270,00	1 223,14 1 480,00	1 338,84 1 620,00	1 200,00 1 452,00	1 304,13 1 578,00	1 396,69 1 690,00	1 619,83 1 960,00	1 634,71 1 978,00
2 x GLU 0064B + EKT 0003 + EKT 0001H	GLU S10T18	1 049,59 1 270,00	1 223,14 1 480,00	1 338,84 1 620,00	1 200,00 1 452,00	1 304,13 1 578,00	1 396,69 1 690,00	1 619,83 1 960,00	1 634,71 1 978,00
2 x GLU 0064 + EKT 0003 + EKT 0001H	GLU S10T20	1 049,59 1 270,00	1 223,14 1 480,00	1 338,84 1 620,00	1 200,00 1 452,00	1 304,13 1 578,00	1 396,69 1 690,00	1 619,83 1 960,00	1 634,71 1 978,00
2 x GLU 0061B + EKW 2021M	GLU S10W71	935,54 1 132,00	1 087,60 1 316,00	1 186,78 1 436,00	1 067,77 1 292,00	1 158,68 1 402,00	1 242,98 1 504,00	1 433,06 1 734,00	1 449,59 1 754,00
2 x GLU 0061 + EKW 2021M	GLU S10W72	935,54 1 132,00	1 087,60 1 316,00	1 186,78 1 436,00	1 067,77 1 292,00	1 158,68 1 402,00	1 242,98 1 504,00	1 433,06 1 734,00	1 449,59 1 754,00
2 x GLU 0064B + EKW 2021M	GLU S10W73	1 123,97 1 360,00	1 305,79 1 580,00	1 426,45 1 726,00	1 282,64 1 552,00	1 391,74 1 684,00	1 490,91 1 804,00	1 722,31 2 084,00	1 740,50 2 106,00
2 x GLU 0064 + EKW 2021M	GLU S10W74	1 123,97 1 360,00	1 305,79 1 580,00	1 426,45 1 726,00	1 282,64 1 552,00	1 391,74 1 684,00	1 490,91 1 804,00	1 722,31 2 084,00	1 740,50 2 106,00
2 x GLL 1061B + EKT 0003 + EKT 0001E	GLL S10T02	709,09 858,00	828,10 1 002,00	905,79 1 096,00	813,22 984,00	882,64 1 068,00	947,11 1 146,00	1 097,52 1 328,00	1 109,09 1 342,00
2 x GLL 1061B + EKT 0003 + EKT 0001F	GLL S10T04	709,09 858,00	828,10 1 002,00	905,79 1 096,00	813,22 984,00	882,64 1 068,00	947,11 1 146,00	1 097,52 1 328,00	1 109,09 1 342,00
2 x GLL 1061B + EKT 0003 + EKT 0001G	GLL S10T06	709,09 858,00	828,10 1 002,00	905,79 1 096,00	813,22 984,00	882,64 1 068,00	947,11 1 146,00	1 097,52 1 328,00	1 109,09 1 342,00
2 x GLU 0061B + EKT 0003 + EKT 0001E	GLU S10T02	861,16 1 042,00	1 004,96 1 216,00	1 099,17 1 330,00	985,12 1 192,00	1 071,07 1 296,00	1 148,76 1 390,00	1 330,58 1 610,00	1 343,80 1 626,00
2 x GLU 0061B + EKT 0003 + EKT 0001F	GLU S10T04	861,16 1 042,00	1 004,96 1 216,00	1 099,17 1 330,00	985,12 1 192,00	1 071,07 1 296,00	1 148,76 1 390,00	1 330,58 1 610,00	1 343,80 1 626,00
2 x GLU 0061B + EKT 0003 + EKT 0001G	GLU S10T06	861,16 1 042,00	1 004,96 1 216,00	1 099,17 1 330,00	985,12 1 192,00	1 071,07 1 296,00	1 148,76 1 390,00	1 330,58 1 610,00	1 343,80 1 626,00
2 x GLU 0061B + EKT 0003 + EKT 0001H	GLU S10T21	861,16 1 042,00	1 004,96 1 216,00	1 099,17 1 330,00	985,12 1 192,00	1 071,07 1 296,00	1 148,76 1 390,00	1 330,58 1 610,00	1 343,80 1 626,00

Izdevīgāka
cena,
iegādājoties
komplektā

Cenas bez PVN, Euro
Cenas ar PVN, Euro

					
MK06 + MK31 78x118 + 78x60	MK06 + MK35 78x118 + 78x95	MK08 + MK31 78x140 + 78x60	MK08 + MK35 78x140 + 78x95	MK10 + MK31 78x160 + 78x60	MK10 + MK35 78x160 + 78x95

KOMBINĒTAIS RISINĀJUMS AR VERTIKĀLAJEM LOGA ELEMENTIEM

VFE 3068 + GLL 1061B	GLL S10003	845,45 1 023,00	-	871,90 1 055,00	-	935,54 1 132,00	-
VFE 3068 + GLL 1061B	GLL S10004	-	912,40 1 104,00	-	938,84 1 136,00	-	1 002,48 1 213,00
VFE 3068 + GLL 1064B	GLL S10007	939,67 1 137,00	-	972,73 1 177,00	-	1 052,07 1 273,00	-
VFE 3068 + GLL 1064B	GLL S10008	-	1 006,61 1 218,00	-	1 039,67 1 258,00	-	1 119,01 1 354,00
VFE 3068 + GLL 1061	GLL S10009	845,45 1 023,00	-	871,90 1 055,00	-	935,54 1 132,00	-
VFE 3068 + GLL 1064	GLL S10010	939,67 1 137,00	-	972,73 1 177,00	-	1 052,07 1 273,00	-
VFE 3068 + GLL 1061	GLL S10011	-	912,40 1 104,00	-	938,84 1 136,00	-	1 002,48 1 213,00
VFE 3068 + GLL 1064	GLL S10012	-	1 006,61 1 218,00	-	1 039,67 1 258,00	-	1 119,01 1 354,00

<i>Izmērs (cm)</i>	CK02 55x78	CK04 55x98	CK06 55x118	FK04 66x98	FK06 66x118	FK08 66x140	MK04 78x98	MK06 78x118
--------------------	---------------	---------------	----------------	---------------	----------------	----------------	---------------	----------------

PAMATA PIESLĒGUMA KOMPLEKTS AR HIDRO UN SILTUMIZOLĀCIJU

EDJ 2000 + BBX 0000	EDJ S00J01	164,46 199,00	168,60 204,00	173,55 210,00	173,55 210,00	185,95 225,00	194,21 235,00	185,95 225,00	194,21 235,00
EDS 2000 + BBX 0000	EDS S00S01	140,50 170,00	142,98 173,00	147,93 179,00	147,93 179,00	157,85 191,00	165,29 200,00	157,85 191,00	165,29 200,00
EDT 2000 + BBX 0000	EDT S00T01	140,50 170,00	142,98 173,00	147,93 179,00	147,93 179,00	157,85 191,00	165,29 200,00	157,85 191,00	165,29 200,00
EDW 2000 + BBX 0000	EDW S00W01	140,50 170,00	142,98 173,00	147,93 179,00	147,93 179,00	157,85 191,00	165,29 200,00	157,85 191,00	165,29 200,00
EDZ 2000 + BBX 0000	EDZ S00Z01	147,93 179,00	149,59 181,00	152,07 184,00	152,07 184,00	154,55 187,00	157,02 190,00	152,89 185,00	157,02 190,00
EDQ 2000 + BBX 0000	EDQ ++	-	173,55 210,00	-	-	-	184,30 223,00	180,17 218,00	-

VELUX pieslēguma komplekti ir izstrādāti tā, lai VELUX jumta logi lieliski integrētos jumta segumā. Tie nodrošina pilnīgu aizsardzību no ārpuses un iekšpuses jebkuros laikapstākļos. Komplekts sastāv no pieslēguma, siltumizolācijas rāmja BDx, hidroizolācijas membrānas BFX un tvaika barjeras BBX.

PK08 + PK35
94x140 + 94x95

Izdevīgāka
cena,
iegādājoties
komplektā

-
1 085,95 1 314,00
-
1 203,31 1 456,00
1 085,95 1 314,00
1 203,31 1 456,00
-
-

Izdevīgāka
cena,
iegādājoties
komplektā

MK08 78x140	MK10 78x160	PK06 94x118	PK08 94x140	PK10 94x160	SK06 114x118	SK08 114x140	SK10 114x160	UK04 134x98	UK08 134x140	UK10 134x160
204,96 248,00	224,79 272,00	217,36 263,00	228,10 276,00	234,71 284,00	226,45 274,00	238,84 289,00	247,11 299,00	-	256,20 310,00	282,64 342,00
174,38 211,00	190,08 230,00	184,30 223,00	193,39 234,00	199,17 241,00	191,74 232,00	201,65 244,00	209,09 253,00	201,65 244,00	216,53 262,00	238,84 289,00
174,38 211,00	190,08 230,00	184,30 223,00	193,39 234,00	199,17 241,00	191,74 232,00	201,65 244,00	209,09 253,00	201,65 244,00	216,53 262,00	238,84 289,00
174,38 211,00	190,08 230,00	184,30 223,00	193,39 234,00	199,17 241,00	191,74 232,00	201,65 244,00	209,09 253,00	201,65 244,00	216,53 262,00	238,84 289,00
162,81 197,00	172,73 209,00	168,60 204,00	174,38 211,00	178,51 216,00	173,55 210,00	180,17 218,00	184,30 223,00	180,17 218,00	189,26 229,00	202,48 245,00
-	-	-	206,61 250,00	-	205,79 249,00	214,88 260,00	-	-	226,45 274,00	-

IEBŪVĒŠANAS PIEDERUMI

Cenas bez PVN, Euro
Cenas ar PVN, Euro

Izmērs (cm)

CK02
55x78

CK04
55x98

CK06
55x118

FK04
66x98

FK06
66x118

FK08
66x140

MK04
78x98

MK06
78x118

IEBŪVĒŠANAS PIEDERUMI

Pieslēguma komplekts ar BDX, BFX un drenāžas noteku (BDX WK34 neietilpst drenāžas noteka)













BDX 2000	Hidro un siltumizolācijas komplekts viena jumta loga iebūvēšanai	42,15 51,00	44,63 54,00	46,28 56,00	45,45 55,00	48,76 59,00	50,41 61,00	48,76 59,00	50,41 61,00
BDX 2000F	Hidro un siltumizolācijas komplekts viena jumta loga padziļinātai iebūvēšanai	48,76 59,00	51,24 62,00	53,72 65,00	52,07 63,00	55,37 67,00	57,85 70,00	55,37 67,00	57,85 70,00
BDX 2011	VELUX iebūvēšanas komplekts atbalsta spārei EBĻ	83,47 101,00	87,60 106,00	91,74 111,00	90,08 109,00	95,87 116,00	100,00 121,00	95,87 116,00	100,00 121,00
BDX 2011E	VELUX iebūvēšanas komplekts atbalsta spārei EKY	88,43 107,00	92,56 112,00	96,69 117,00	94,21 114,00	100,83 122,00	104,96 127,00	100,83 122,00	104,96 127,00
BDX 4021B	Iebūvēšanas komplekts 2in1 logu iebūvēšanai	170,25 206,00	174,38 211,00	180,17 218,00	180,17 218,00	194,21 235,00	204,96 248,00	194,21 235,00	204,96 248,00
BDX 4021E	Iebūvēšanas komplekts kombinētai jumta logu iebūvēšanai viens blakus otram	181,82 220,00	186,78 226,00	193,39 234,00	193,39 234,00	208,26 252,00	219,83 266,00	208,26 252,00	219,83 266,00
BDX 4021EF	Iebūvēšanas komplekts kombinētai jumta logu iebūvēšanai viens blakus otram	181,82 220,00	186,78 226,00	193,39 234,00	193,39 234,00	208,26 252,00	219,83 266,00	208,26 252,00	219,83 266,00
BDX 4031B	Iebūvēšanas komplekts kombinētai jumta logu iebūvēšanai viens blakus otram	289,26 350,00	295,87 358,00	306,61 371,00	306,61 371,00	330,58 400,00	347,93 421,00	330,58 400,00	347,93 421,00









Komplekts nodrošina hermētisku jumta loga savienojumu ar jumta konstrukciju

BFX 1000	Hidroizolācijas membrāna viena loga iebūvēšanai	22,31 27,00	23,14 28,00	23,97 29,00	23,97 29,00	24,79 30,00	26,45 32,00	24,79 30,00	26,45 32,00
BFX 1000F	Hidroizolācijas membrāna viena loga padziļinātai iebūvēšanai	23,14 28,00	23,97 29,00	24,79 30,00	24,79 30,00	26,45 32,00	27,27 33,00	26,45 32,00	27,27 33,00
BFX 1000U	Hidroizolācijas membrāna viena loga iebūvēšanai betona jumtā	-	-	-	-	-	-	-	-

Tvaika barjera palīdz novērst mitruma nokļūšanu jumta konstrukcijā. Palīdz hermētiski savienot jumta logu ar esošo tvaika barjeru

BBX 0021B	Tvaika barjera logiem, kas iebūvēti risinājumā viens blakus otram	76,03 92,00	77,69 94,00	79,34 96,00	79,34 96,00	80,99 98,00	84,30 102,00	80,99 98,00	82,64 100,00
BBX 0021E	Tvaika barjera logiem, kas iebūvēti risinājumā viens blakus otram	76,03 92,00	77,69 94,00	79,34 96,00	79,34 96,00	80,99 98,00	84,30 102,00	80,99 98,00	82,64 100,00
BBX 0000	Tvaika barjera	-	25,62 31,00	25,62 31,00	25,62 31,00	25,62 31,00	25,62 31,00	25,62 31,00	25,62 31,00

	 MK08 78x140	 MK10 78x160	 MK12 78x180	 PK06 94x118	 PK08 94x140	 PK10 94x160	 SK06 114x118	 SK08 114x140	 SK10 114x160	 UK04 134x98	 UK08 134x140	 UK10 134x160
	52,89 64,00	54,55 66,00	59,50 72,00	52,89 64,00	54,55 66,00	57,02 69,00	54,55 66,00	57,02 69,00	60,33 73,00	54,55 66,00	59,50 72,00	61,16 74,00
	61,16 74,00	62,81 76,00	68,60 83,00	61,16 74,00	62,81 76,00	65,29 79,00	62,81 76,00	65,29 79,00	68,60 83,00	62,81 76,00	68,60 83,00	71,07 86,00
	104,96 127,00	107,44 130,00	118,18 143,00	104,96 127,00	107,44 130,00	112,40 136,00	109,09 132,00	112,40 136,00	119,01 144,00	109,09 132,00	118,18 143,00	121,49 147,00
	109,92 133,00	113,22 137,00	123,97 150,00	109,92 133,00	113,22 137,00	118,18 143,00	114,05 138,00	118,18 143,00	124,79 151,00	114,05 138,00	123,97 150,00	128,10 155,00
	217,36 263,00	239,67 290,00	243,80 295,00	231,40 280,00	243,80 295,00	252,07 305,00	241,32 292,00	256,20 310,00	266,12 322,00	256,20 310,00	276,86 335,00	-
	232,23 281,00	257,02 311,00	261,16 316,00	247,93 300,00	261,16 316,00	270,25 327,00	258,68 313,00	274,38 332,00	285,12 345,00	274,38 332,00	295,87 358,00	-
	232,23 281,00	257,02 311,00	261,16 316,00	247,93 300,00	261,16 316,00	270,25 327,00	258,68 313,00	274,38 332,00	285,12 345,00	274,38 332,00	295,87 358,00	-
	369,42 447,00	407,44 493,00	414,05 501,00	-	-	-	-	-	-	-	-	-
	27,27 33,00	28,10 34,00	30,58 37,00	27,27 33,00	28,10 34,00	29,75 36,00	28,93 35,00	29,75 36,00	31,40 38,00	28,93 35,00	30,58 37,00	32,23 39,00
	28,93 35,00	29,75 36,00	32,23 39,00	28,93 35,00	29,75 36,00	30,58 37,00	29,75 36,00	30,58 37,00	32,23 39,00	29,75 36,00	32,23 39,00	33,06 40,00
	-	-	-	-	-	-	-	-	-	-	-	-
	85,95 104,00	88,43 107,00	115,70 140,00	85,95 104,00	87,60 106,00	90,91 110,00	88,43 107,00	90,91 110,00	93,39 113,00	92,56 112,00	94,21 114,00	-
	85,95 104,00	88,43 107,00	115,70 140,00	85,95 104,00	87,60 106,00	90,91 110,00	88,43 107,00	90,91 110,00	93,39 113,00	92,56 112,00	94,21 114,00	-
	25,62 31,00	25,62 31,00	25,62 31,00	25,62 31,00	25,62 31,00	25,62 31,00	25,62 31,00	25,62 31,00	25,62 31,00	25,62 31,00	25,62 31,00	25,62 31,00

Cenas bez PVN, Euro Cenas ar PVN, Euro								
Izmērs (cm)	CK02 55x78	CK04 55x98	CK06 55x118	FK04 66x98	FK06 66x118	FK08 66x140	MK04 78x98	MK06 78x118









AILES APDARE

Iebūvēšanas
slīpums

Gatavs risinājums ailes apdarei. Aile veidota no ūdens izturīgiem materiāliem un ideāli sader ar VELUX jumta logu

LSB 2000	Ailes apdare jumta biežumam līdz 300 mm, viena loga iebūvēšanai	15-90	223,97 271,00	228,93 277,00	233,88 283,00	233,88 283,00	238,84 289,00	248,76 301,00	238,84 289,00	243,80 295,00
LSB 2021B	Ailes apdare jumta biežumam līdz 300 mm, divu logu kombinētai iebūvēšanai	15-90	448,76 543,00	458,68 555,00	467,77 566,00	467,77 566,00	477,69 578,00	497,52 602,00	477,69 578,00	487,60 590,00
LSB 2021E	Ailes apdare jumta biežumam līdz 300 mm, kombinētai iebūvēšanai	15-90	448,76 543,00	458,68 555,00	467,77 566,00	467,77 566,00	477,69 578,00	497,52 602,00	477,69 578,00	487,60 590,00
LSB 2031B	Ailes apdare jumta biežumam līdz 300 mm, trīs logu kombinētai iebūvēšanai	15-90	672,73 814,00	687,60 832,00	702,48 850,00	702,48 850,00	716,53 867,00	746,28 903,00	716,53 867,00	731,40 885,00
LSB 2031E	Ailes apdare jumta biežumam līdz 300 mm, trīs logu kombinētai iebūvēšanai	15-90	672,73 814,00	687,60 832,00	702,48 850,00	702,48 850,00	716,53 867,00	746,28 903,00	716,53 867,00	731,40 885,00
LSC 2000	Ailes apdare jumta biežumam līdz 400 mm, viena loga iebūvēšanai	15-90	280,17 339,00	286,78 347,00	292,56 354,00	292,56 354,00	298,35 361,00	310,74 376,00	298,35 361,00	304,96 369,00
LSC 2021B	Ailes apdare jumta biežumam līdz 400 mm, divu logu kombinētai iebūvēšanai	15-90	561,16 679,00	572,73 693,00	585,12 708,00	585,12 708,00	597,52 723,00	621,49 752,00	597,52 723,00	609,92 738,00
LSC 2021E	Ailes apdare jumta biežumam līdz 400 mm, kombinētai iebūvēšanai	15-90	561,16 679,00	572,73 693,00	585,12 708,00	585,12 708,00	597,52 723,00	621,49 752,00	597,52 723,00	609,92 738,00
LSC 2031B	Ailes apdare jumta biežumam līdz 400 mm, divu logu kombinētai iebūvēšanai	15-90	841,32 1 018,00	859,50 1 040,00	877,69 1 062,00	877,69 1 062,00	895,87 1 084,00	932,23 1 128,00	895,87 1 084,00	914,05 1 106,00
LSD 2000	Ailes apdare jumta biežumam līdz 500 mm, viena loga iebūvēšanai	15-90	380,99 461,00	389,26 471,00	397,52 481,00	397,52 481,00	405,79 491,00	423,14 512,00	405,79 491,00	414,88 502,00
LSD 2021B	Ailes apdare jumta biežumam līdz 500 mm, kombinētai divu logu iebūvēšanai	15-90	257,85 312,00	263,64 319,00	268,60 325,00	268,60 325,00	274,38 332,00	285,95 346,00	274,38 332,00	280,17 339,00
LSD 2021E	Ailes apdare jumta biežumam līdz 500 mm, kombinētai iebūvēšanai	15-90	257,85 312,00	263,64 319,00	268,60 325,00	268,60 325,00	274,38 332,00	285,95 346,00	274,38 332,00	280,17 339,00











Ailes apdare LSB, LSC, LSD ir saderīga gan ar VELUX jaunākās paaudzes jumta logiem, gan ar iepriekšējās paaudzes jumta logiem.

Cenas bez PVN, Euro Cenas ar PVN, Euro								
Izmērs (cm)	CK02 55x78	CK04 55x98	CK06 55x118	FK04 66x98	FK06 66x118	FK08 66x140	MK04 78x98	MK06 78x118













ZWC: SĀNU UN APAKŠĒJĀS MALAS UZLIKAS AR PAGARINĀJUMU AUGŠĒJAI MALAI

Iebūvēšanas
slīpums

ZWC 0000	Uzliku komplekts, kurā ietilpst apakšējais un sānu rāmju pārsegi, ZWC ir nepieciešams, ja vēlaties iebūvēt VELUX jumta logu, neizmantojot VELUX pieslēgumu.	-	21,49 26,00	23,97 29,00	25,62 31,00	25,62 31,00	28,10 34,00	29,75 36,00	27,27 33,00	28,93 35,00
ZWC 0000T	Uzliku komplekts, kurā ietilpst apakšējais un sānu rāmju pārsegi, kā arī pagarinājums augšējām pārsegam, ZWC ir nepieciešams, ja vēlaties iebūvēt VELUX jumta logu, neizmantojot VELUX pieslēgumu.	-	21,49 26,00	23,97 29,00	25,62 31,00	25,62 31,00	28,10 34,00	29,75 36,00	27,27 33,00	28,93 35,00



 MK08 78x140	 MK12 78x180	 PK06 94x118	 PK08 94x140	 PK10 94x160	 SK06 114x118	 SK08 114x140	 SK10 114x160	 UK04 134x98	 UK08 134x140	 UK10 134x160
---	---	---	---	---	--	--	--	---	--	--

253,72 307,00	341,32 413,00	253,72 307,00	258,68 313,00	268,60 325,00	261,16 316,00	268,60 325,00	275,21 333,00	272,73 330,00	277,69 336,00	285,12 345,00
507,44 614,00	682,64 826,00	507,44 614,00	516,53 625,00	536,36 649,00	521,49 631,00	536,36 649,00	551,24 667,00	546,28 661,00	556,20 673,00	570,25 690,00
507,44 614,00	682,64 826,00	507,44 614,00	516,53 625,00	536,36 649,00	521,49 631,00	536,36 649,00	551,24 667,00	546,28 661,00	556,20 673,00	570,25 690,00
760,33 920,00	1 023,97 1 239,00	-	-	-	-	-	-	-	-	-
760,33 920,00	1 023,97 1 239,00	-	-	-	-	-	-	-	-	-
317,36 384,00	426,45 516,00	317,36 384,00	323,14 391,00	335,54 406,00	326,45 395,00	335,54 406,00	344,63 417,00	341,32 413,00	347,11 420,00	356,20 431,00
633,88 767,00	853,72 1 033,00	633,88 767,00	646,28 782,00	670,25 811,00	652,07 789,00	670,25 811,00	688,43 833,00	682,64 826,00	695,04 841,00	713,22 863,00
633,88 767,00	853,72 1 033,00	633,88 767,00	646,28 782,00	670,25 811,00	652,07 789,00	670,25 811,00	688,43 833,00	682,64 826,00	695,04 841,00	713,22 863,00
951,24 1 151,00	1 280,17 1 549,00	-	-	-	-	-	-	-	-	-
431,40 522,00	580,17 702,00	431,40 522,00	439,67 532,00	456,20 552,00	443,80 537,00	456,20 552,00	468,60 567,00	464,46 562,00	472,73 572,00	485,12 587,00
291,74 353,00	392,56 475,00	-	-	-	-	-	-	-	-	-
291,74 353,00	392,56 475,00	-	-	-	-	-	-	-	-	-

 MK08 78x140	 MK10 78x160	 MK12 78x180	 PK06 94x118	 PK08 94x140	 PK10 94x160	 SK06 114x118	 SK08 114x140	 SK10 114x160	 UK04 134x98	 UK08 134x140	 UK10 134x160
---	---	---	---	---	---	--	--	--	---	--	--

30,58 37,00	36,36 44,00	41,32 50,00	33,88 41,00	36,36 44,00	39,67 48,00	36,36 44,00	40,50 49,00	44,63 54,00	37,19 45,00	44,63 54,00	50,41 61,00
30,58 37,00	36,36 44,00	41,32 50,00	33,88 41,00	36,36 44,00	39,67 48,00	36,36 44,00	40,50 49,00	44,63 54,00	37,19 45,00	44,63 54,00	50,41 61,00

ŽALŪZIJAS UN SLĒGI

Jumta logiem, kuri ražoti no 2014. gada										
Loga kods	CK02	CK04	CK06	FK04	FK06	FK08	MK04	MK06		
Slēgi	CK02	CK04	CK06	FK04	FK06	FK08	MK04	MK06		
Žalūzijas/saulessargs ar slīdēm	CK02	CK04	CK06	FK04	FK06	FK08	MK04	MK06		
Žalūzijas/saulessargs ar āķiem	CK00	CK00	CK00	FK00	FK00	FK00	MK00	MK00		
Jumta logiem, kuri ražoti no 2003. līdz 2014. gadam										
Loga kods	C02	C04	C06	F04	F06	F08	M04	M06		
Slēgi	CK02	CK04	CK06	FK04	FK06	FK08	MK04	MK06		
Žalūzijas/saulessargs ar slīdēm	C02	C04	C06	F04	F06	F08	M04	M06		
Žalūzijas/saulessargs ar āķiem	CK00	CK00	CK00	FK00	FK00	FK00	MK00	MK00		
Jumta logiem, kuri ražoti no 1992. līdz 2003. gadam										
Loga kods	102	104	-	204	206	-	304	306		
Slēgi	CK02	CK04	-	FK04	FK06	-	MK04	MK06		
Žalūzijas/saulessargs ar slīdēm	102	104	-	204	206	-	M04	M06		
Žalūzijas/saulessargs ar āķiem	100	100	-	200	200	-	MK00	MK00		
Kods	Darbība	Krāsa	Loga rāmja izmērs (cm)							
			55x78	55x98	55x118	66x98	66x118	66x140	78x98	78x118
Cenas bez PVN, Euro										
Cenas ar PVN, Euro			CK02	CK04	CK06	FK04	FK06	FK08	MK04	MK06

GAISMAS KONTROLE

Ruļļveida žalūzijas ar āķiem

RHL	Manuāla	standarta		36,36 44,00			42,15 51,00		45,45 55,00	
-----	---------	-----------	--	-----------------------	--	--	-----------------------	--	-----------------------	--

Ruļļveida žalūzijas

RFY	Manuāla	Dabas kolekcija	82,64 100,00	87,60 106,00	95,04 115,00	94,21 114,00	100,83 122,00	104,13 126,00	97,52 118,00	104,13 126,00
RFL	Manuāla	standarta	61,98 75,00	66,12 80,00	72,73 88,00	71,90 87,00	77,69 94,00	80,99 98,00	75,21 91,00	80,99 98,00
	Manuāla	dizaina, Colour by You	76,03 92,00	80,17 97,00	86,78 105,00	85,95 104,00	91,74 111,00	95,04 115,00	89,26 108,00	95,04 115,00
RML	Elektriska	standarta	152,07 184,00	156,20 189,00	162,81 197,00	161,98 196,00	167,77 203,00	171,07 207,00	165,29 200,00	171,07 207,00
	Elektriska	dizaina, Colour by You	166,12 201,00	170,25 206,00	176,86 214,00	176,03 213,00	181,82 220,00	185,12 224,00	179,34 217,00	185,12 224,00
RSL	Solāra	standarta	152,07 184,00	156,20 189,00	162,81 197,00	161,98 196,00	167,77 203,00	171,07 207,00	165,29 200,00	171,07 207,00
	Solāra	dizaina, Colour by You	166,12 201,00	170,25 206,00	176,86 214,00	176,03 213,00	181,82 220,00	185,12 224,00	179,34 217,00	185,12 224,00

Gaismu necaurļaidīgās žalūzijas

DKY	Manuāla	Dabas kolekcija	82,64 100,00	87,60 106,00	95,04 115,00	94,21 114,00	100,83 122,00	104,13 126,00	97,52 118,00	104,13 126,00
DKL	Manuāla	standarta	68,60 83,00	73,55 89,00	80,99 98,00	80,17 97,00	86,78 105,00	90,08 109,00	83,47 101,00	90,08 109,00
	Manuāla	dizaina, Colour by You, Kolekcija bērniem	82,64 100,00	87,60 106,00	95,04 115,00	94,21 114,00	100,83 122,00	104,13 126,00	97,52 118,00	104,13 126,00
DML	Elektriska	standarta	158,68 192,00	163,64 198,00	171,07 207,00	170,25 206,00	176,86 214,00	180,17 218,00	173,55 210,00	180,17 218,00
	Elektriska	dizaina, Colour by You	172,73 209,00	177,69 215,00	185,12 224,00	184,30 223,00	190,91 231,00	194,21 235,00	187,60 227,00	194,21 235,00
DSL	Solāra	standarta	158,68 192,00	163,64 198,00	171,07 207,00	170,25 206,00	176,86 214,00	180,17 218,00	173,55 210,00	180,17 218,00
	Solāra	dizaina, Colour by You	172,73 209,00	177,69 215,00	185,12 224,00	184,30 223,00	190,91 231,00	194,21 235,00	187,60 227,00	194,21 235,00

DUO gaismu necaurļaidīgās žalūzijas

DFD	Manuāla	standarta	89,26 108,00	95,87 116,00	105,79 128,00	104,13 126,00	112,40 136,00	117,36 142,00	109,09 132,00	117,36 142,00
	Manuāla	dizaina, Colour by You, Kolekcija bērniem	103,31 125,00	109,92 133,00	119,83 145,00	118,18 143,00	126,45 153,00	131,40 159,00	123,14 149,00	131,40 159,00

	MK08	MK10	MK12	PK06	PK08	PK10	SK06	SK08	SK10	UK04	UK08	UK10
	MK08	MK10	MK12	PK06	PK08	PK10	SK06	SK08	SK10	UK04	UK08	UK10
	MK08	MK10	MK12	PK06	PK08	PK10	SK06	SK08	SK10	UK04	UK08	UK10
	MK00	MK00	MK12	PK00	PK00	PK00	SK00	SK00	SK00	UK00	UK00	UK00

	M08	M10	M12	P06	P08	P10	S06	S08	S10	U04	U08	U10
	MK08	MK10	MK12	PK06	PK08	PK10	SK06	SK08	SK10	UK04	UK08	UK10
	M08	M10	M12	P06	P08	P10	S06	S08	S10	U04	U08	U10
	MK00	MK00	MK12	PK00	PK00	PK00	SK00	SK00	SK10	UK00	UK00	UK00

	308	310	-	406	408	410	606	608	610	804	808	810
	MK08	MK10	-	PK06	PK08	PK10	SK06	SK08	SK10	UK04	UK08	UK10
	M08	M10	-	P06	P08	P10	S06	S08	S10	U04	U08	U10
	MK00	MK00	-	PK00	PK00	PK00	SK00	SK00	SK00	UK00	UK00	UK00



	78x140	78x160	78x180	94x118	94x140	94x160	114x118	114x140	114x160	134x98	134x140	134x160
	MK08	MK10	MK12	PK06	PK08	PK10	SK06	SK08	SK10	UK04	UK08	UK10

	45,45	-	52,07	57,85	62,81
	55,00		63,00	70,00	76,00

	110,74	122,31	131,40	113,22	122,31	128,10	126,45	131,40	144,63	129,75	146,28	152,89
	134,00	148,00	159,00	137,00	148,00	155,00	153,00	159,00	175,00	157,00	177,00	185,00
	86,78	97,52	105,79	89,26	97,52	103,31	101,65	105,79	117,36	104,13	119,01	124,79
	105,00	118,00	128,00	108,00	118,00	125,00	123,00	128,00	142,00	126,00	144,00	151,00
	100,83	111,57	119,83	103,31	111,57	117,36	115,70	119,83	131,40	118,18	133,06	138,84
	122,00	135,00	145,00	125,00	135,00	142,00	140,00	145,00	159,00	143,00	161,00	168,00
	176,86	187,60	195,87	179,34	187,60	193,39	191,74	195,87	207,44	194,21	209,09	214,88
	214,00	227,00	237,00	217,00	227,00	234,00	232,00	237,00	251,00	235,00	253,00	260,00
	190,91	201,65	209,92	193,39	201,65	207,44	205,79	209,92	221,49	208,26	223,14	228,93
	231,00	244,00	254,00	234,00	244,00	251,00	249,00	254,00	268,00	252,00	270,00	277,00
	176,86	187,60	195,87	179,34	187,60	193,39	191,74	195,87	207,44	194,21	209,09	214,88
	214,00	227,00	237,00	217,00	227,00	234,00	232,00	237,00	251,00	235,00	253,00	260,00
	190,91	201,65	209,92	193,39	201,65	207,44	205,79	209,92	221,49	208,26	223,14	228,93
	231,00	244,00	254,00	234,00	244,00	251,00	249,00	254,00	268,00	252,00	270,00	277,00

	110,74	122,31	131,40	113,22	122,31	128,10	126,45	131,40	144,63	129,75	146,28	152,89
	134,00	148,00	159,00	137,00	148,00	155,00	153,00	159,00	175,00	157,00	177,00	185,00
	96,69	108,26	117,36	99,17	108,26	114,05	112,40	117,36	130,58	115,70	132,23	138,84
	117,00	131,00	142,00	120,00	131,00	138,00	136,00	142,00	158,00	140,00	160,00	168,00
	110,74	122,31	131,40	113,22	122,31	128,10	126,45	131,40	144,63	129,75	146,28	152,89
	134,00	148,00	159,00	137,00	148,00	155,00	153,00	159,00	175,00	157,00	177,00	185,00
	186,78	198,35	207,44	189,26	198,35	204,13	202,48	207,44	220,66	205,79	222,31	228,93
	226,00	240,00	251,00	229,00	240,00	247,00	245,00	251,00	267,00	249,00	269,00	277,00
	200,83	212,40	221,49	203,31	212,40	218,18	216,53	221,49	234,71	219,83	236,36	242,98
	243,00	257,00	268,00	246,00	257,00	264,00	262,00	268,00	284,00	266,00	286,00	294,00
	186,78	198,35	207,44	189,26	198,35	204,13	202,48	207,44	220,66	205,79	222,31	228,93
	226,00	240,00	251,00	229,00	240,00	247,00	245,00	251,00	267,00	249,00	269,00	277,00
	200,83	212,40	221,49	203,31	212,40	218,18	216,53	221,49	234,71	219,83	236,36	242,98
	243,00	257,00	268,00	246,00	257,00	264,00	262,00	268,00	284,00	266,00	286,00	294,00

	125,62	140,50	-	128,93	140,50	148,76	146,28	152,07	169,42	149,59	171,90	180,17
	152,00	170,00		156,00	170,00	180,00	177,00	184,00	205,00	181,00	208,00	218,00
	139,67	154,55	-	142,98	154,55	162,81	160,33	166,12	183,47	163,64	185,95	194,21
	169,00	187,00		173,00	187,00	197,00	194,00	201,00	222,00	198,00	225,00	235,00

Jumta logiem, kuri ražoti no 2014. gada										
Loga kods	CK02	CK04	CK06	FK04	FK06	FK08	MK04	MK06		
Slēgi	CK02	CK04	CK06	FK04	FK06	FK08	MK04	MK06		
Žalūzijas/saulessargs ar sliedēm	CK02	CK04	CK06	FK04	FK06	FK08	MK04	MK06		
Žalūzijas/saulessargs ar āķiem	CK00	CK00	CK00	FK00	FK00	FK00	MK00	MK00		
Jumta logiem, kuri ražoti no 2003. līdz 2014. gadam										
Loga kods	C02	C04	C06	F04	F06	F08	M04	M06		
Slēgi	CK02	CK04	CK06	FK04	FK06	FK08	MK04	MK06		
Žalūzijas/saulessargs ar sliedēm	C02	C04	C06	F04	F06	F08	M04	M06		
Žalūzijas/saulessargs ar āķiem	CK00	CK00	CK00	FK00	FK00	FK00	MK00	MK00		
Jumta logiem, kuri ražoti no 1992. līdz 2003. gadam										
Loga kods	102	104	-	204	206	-	304	306		
Slēgi	CK02	CK04	-	FK04	FK06	-	MK04	MK06		
Žalūzijas/saulessargs ar sliedēm	102	104	-	204	206	-	M04	M06		
Žalūzijas/saulessargs ar āķiem	100	100	-	200	200	-	MK00	MK00		
Kods	Darbība	Krāsa	Loga rāmja izmērs (cm)							
			55x78	55x98	55x118	66x98	66x118	66x140	78x98	78x118
Cenas bez PVN, Euro			CK02	CK04	CK06	FK04	FK06	FK08	MK04	MK06
Cenas ar PVN, Euro										
Plisētās žalūzijas										
FHL	Manuāla	standarta	89,26 108,00	95,87 116,00	105,79 128,00	104,13 126,00	112,40 136,00	117,36 142,00	109,09 132,00	117,36 142,00
	Manuāla	dizaina	103,31 125,00	109,92 133,00	119,83 145,00	118,18 143,00	126,45 153,00	131,40 159,00	123,14 149,00	131,40 159,00
FML	Elektriska	standarta	179,34 217,00	185,95 225,00	195,87 237,00	194,21 235,00	202,48 245,00	207,44 251,00	199,17 241,00	207,44 251,00
	Elektriska	dizaina	193,39 234,00	200,00 242,00	209,92 254,00	208,26 252,00	216,53 262,00	221,49 268,00	213,22 258,00	221,49 268,00
FSL	Solāra	standarta	179,34 217,00	185,95 225,00	195,87 237,00	194,21 235,00	202,48 245,00	207,44 251,00	199,17 241,00	207,44 251,00
	Solāra	dizaina	193,39 234,00	200,00 242,00	209,92 254,00	208,26 252,00	216,53 262,00	221,49 268,00	213,22 258,00	221,49 268,00
Energoefektīvās gaismu necaurlaidīgās žalūzijas										
FHC	Manuāla	standarta	89,26 108,00	95,87 116,00	105,79 128,00	104,13 126,00	112,40 136,00	117,36 142,00	109,09 132,00	117,36 142,00
	Manuāla	dizaina	103,31 125,00	109,92 133,00	119,83 145,00	118,18 143,00	126,45 153,00	131,40 159,00	123,14 149,00	131,40 159,00
FMC	Elektriska	standarta	179,34 217,00	185,95 225,00	195,87 237,00	194,21 235,00	202,48 245,00	207,44 251,00	199,17 241,00	207,44 251,00
	Elektriska	dizaina	193,39 234,00	200,00 242,00	209,92 254,00	208,26 252,00	216,53 262,00	221,49 268,00	213,22 258,00	221,49 268,00
FSC	Solāra	standarta	179,34 217,00	185,95 225,00	195,87 237,00	194,21 235,00	202,48 245,00	207,44 251,00	199,17 241,00	207,44 251,00
	Solāra	dizaina	193,39 234,00	200,00 242,00	209,92 254,00	208,26 252,00	216,53 262,00	221,49 268,00	213,22 258,00	221,49 268,00
Horizontālās žalūzijas										
PAL	Manuāla	standarta	89,26 108,00	95,87 116,00	105,79 128,00	104,13 126,00	112,40 136,00	117,36 142,00	109,09 132,00	117,36 142,00
Klasiskās, aptumšojošās ruļļveida žalūzijas logiem, kas ražoti no 2000. līdz 2012. gadam										
DBL	Manuāla	standarta	47,93 58,00	52,07 63,00	-	56,20 68,00	60,33 73,00	-	58,68 71,00	62,81 76,00

Ruļļveida žalūzijas var pasūtīt ar alumīnija vai baltām sānu sliedēm. Pasūtot vienmēr jānorāda nepieciešamais sānu sliežu veids, izņemot RHZ un RHL.

Piemērs: DKL MK06 1025S – alumīnija sliedes

DKL MK06 1025SWL – baltas sliedes

Piederumi jāpasūta atbilstoši jumta loga kodam. Šī brīža jumta loga paaudzes kods ietver burtu K, piemēram, MK06, tāda paša izmēra iepriekšējās paaudzes izmēra kods ir bez burta K, piemēram, M06.

Lai pasūtītu slēgus un žalūzijas jumta logiem, kas iegādāti pirms 2002. gada, lūdzam sazināties ar klientu servisu.

Elektriski vadāmi piederumi ir paredzēti savienošanai ar GGL/GGU elektriskajiem jumta logiem vai KUX 110 vadības bloku. Uzstādot tālvadības produktus uz manuāli vadāmiem logiem vai logiem ar KMG motora bloku, nepieciešams pasūtīt ZOZ 241/243 adapteri.

	MK08	MK10	MK12	PK06	PK08	PK10	SK06	SK08	SK10	UK04	UK08	UK10
	MK08	MK10	MK12	PK06	PK08	PK10	SK06	SK08	SK10	UK04	UK08	UK10
	MK08	MK10	MK12	PK06	PK08	PK10	SK06	SK08	SK10	UK04	UK08	UK10
	MK00	MK00	MK12	PK00	PK00	PK00	SK00	SK00	SK00	UK00	UK00	UK00

	M08	M10	M12	P06	P08	P10	S06	S08	S10	U04	U08	U10
	MK08	MK10	MK12	PK06	PK08	PK10	SK06	SK08	SK10	UK04	UK08	UK10
	M08	M10	M12	P06	P08	P10	S06	S08	S10	U04	U08	U10
	MK00	MK00	MK12	PK00	PK00	PK00	SK00	SK00	SK10	UK00	UK00	UK00

	308	310	-	406	408	410	606	608	610	804	808	810
	MK08	MK10	-	PK06	PK08	PK10	SK06	SK08	SK10	UK04	UK08	UK10
	M08	M10	-	P06	P08	P10	S06	S08	S10	U04	U08	U10
	MK00	MK00	-	PK00	PK00	PK00	SK00	SK00	SK00	UK00	UK00	UK00

	78x140	78x160	78x180	94x118	94x140	94x160	114x118	114x140	114x160	134x98	134x140	134x160
	MK08	MK10	MK12	PK06	PK08	PK10	SK06	SK08	SK10	UK04	UK08	UK10

	125,62 152,00	140,50 170,00	152,07 184,00	128,93 156,00	140,50 170,00	148,76 180,00	146,28 177,00	152,07 184,00	169,42 205,00	149,59 181,00	171,90 208,00	180,17 218,00
--	-------------------------	-------------------------	-------------------------	-------------------------	-------------------------	-------------------------	-------------------------	-------------------------	-------------------------	-------------------------	-------------------------	-------------------------

	139,67 169,00	154,55 187,00	166,12 201,00	142,98 173,00	154,55 187,00	162,81 197,00	160,33 194,00	166,12 201,00	183,47 222,00	163,64 198,00	185,95 225,00	194,21 235,00
--	-------------------------	-------------------------	-------------------------	-------------------------	-------------------------	-------------------------	-------------------------	-------------------------	-------------------------	-------------------------	-------------------------	-------------------------

	215,70 261,00	230,58 279,00	242,15 293,00	219,01 265,00	230,58 279,00	238,84 289,00	236,36 286,00	242,15 293,00	259,50 314,00	239,67 290,00	261,98 317,00	270,25 327,00
--	-------------------------	-------------------------	-------------------------	-------------------------	-------------------------	-------------------------	-------------------------	-------------------------	-------------------------	-------------------------	-------------------------	-------------------------

	229,75 278,00	244,63 296,00	256,20 310,00	233,06 282,00	244,63 296,00	252,89 306,00	250,41 303,00	256,20 310,00	273,55 331,00	253,72 307,00	276,03 334,00	284,30 344,00
--	-------------------------	-------------------------	-------------------------	-------------------------	-------------------------	-------------------------	-------------------------	-------------------------	-------------------------	-------------------------	-------------------------	-------------------------

	215,70 261,00	230,58 279,00	242,15 293,00	219,01 265,00	230,58 279,00	238,84 289,00	236,36 286,00	242,15 293,00	259,50 314,00	239,67 290,00	261,98 317,00	270,25 327,00
--	-------------------------	-------------------------	-------------------------	-------------------------	-------------------------	-------------------------	-------------------------	-------------------------	-------------------------	-------------------------	-------------------------	-------------------------

	229,75 278,00	244,63 296,00	256,20 310,00	233,06 282,00	244,63 296,00	252,89 306,00	250,41 303,00	256,20 310,00	273,55 331,00	253,72 307,00	276,03 334,00	284,30 344,00
--	-------------------------	-------------------------	-------------------------	-------------------------	-------------------------	-------------------------	-------------------------	-------------------------	-------------------------	-------------------------	-------------------------	-------------------------

	125,62 152,00	140,50 170,00	152,07 184,00	128,93 156,00	140,50 170,00	148,76 180,00	146,28 177,00	152,07 184,00	169,42 205,00	149,59 181,00	171,90 208,00	180,17 218,00
--	-------------------------	-------------------------	-------------------------	-------------------------	-------------------------	-------------------------	-------------------------	-------------------------	-------------------------	-------------------------	-------------------------	-------------------------

	139,67 169,00	154,55 187,00	166,12 201,00	142,98 173,00	154,55 187,00	162,81 197,00	160,33 194,00	166,12 201,00	183,47 222,00	163,64 198,00	185,95 225,00	194,21 235,00
--	-------------------------	-------------------------	-------------------------	-------------------------	-------------------------	-------------------------	-------------------------	-------------------------	-------------------------	-------------------------	-------------------------	-------------------------

	215,70 261,00	230,58 279,00	242,15 293,00	219,01 265,00	230,58 279,00	238,84 289,00	236,36 286,00	242,15 293,00	259,50 314,00	239,67 290,00	261,98 317,00	270,25 327,00
--	-------------------------	-------------------------	-------------------------	-------------------------	-------------------------	-------------------------	-------------------------	-------------------------	-------------------------	-------------------------	-------------------------	-------------------------

	229,75 278,00	244,63 296,00	256,20 310,00	233,06 282,00	244,63 296,00	252,89 306,00	250,41 303,00	256,20 310,00	273,55 331,00	253,72 307,00	276,03 334,00	284,30 344,00
--	-------------------------	-------------------------	-------------------------	-------------------------	-------------------------	-------------------------	-------------------------	-------------------------	-------------------------	-------------------------	-------------------------	-------------------------

	215,70 261,00	230,58 279,00	242,15 293,00	219,01 265,00	230,58 279,00	238,84 289,00	236,36 286,00	242,15 293,00	259,50 314,00	239,67 290,00	261,98 317,00	270,25 327,00
--	-------------------------	-------------------------	-------------------------	-------------------------	-------------------------	-------------------------	-------------------------	-------------------------	-------------------------	-------------------------	-------------------------	-------------------------

	229,75 278,00	244,63 296,00	256,20 310,00	233,06 282,00	244,63 296,00	252,89 306,00	250,41 303,00	256,20 310,00	273,55 331,00	253,72 307,00	276,03 334,00	284,30 344,00
--	-------------------------	-------------------------	-------------------------	-------------------------	-------------------------	-------------------------	-------------------------	-------------------------	-------------------------	-------------------------	-------------------------	-------------------------

	125,62 152,00	140,50 170,00	152,07 184,00	128,93 156,00	140,50 170,00	148,76 180,00	146,28 177,00	152,07 184,00	169,42 205,00	149,59 181,00	171,90 208,00	180,17 218,00
--	-------------------------	-------------------------	-------------------------	-------------------------	-------------------------	-------------------------	-------------------------	-------------------------	-------------------------	-------------------------	-------------------------	-------------------------

	67,77 82,00	76,03 92,00	-	69,42 84,00	76,03 92,00	-	78,51 95,00	81,82 99,00	-	80,99 98,00	92,56 112,00	-
--	-----------------------	-----------------------	---	-----------------------	-----------------------	---	-----------------------	-----------------------	---	-----------------------	------------------------	---

Izmēru kods
Rāmja izmērs, cm

CK02
55x78

CK04
55x98

CK06
55x118

FK04
66x98

FK06
66x118

FK08
66x140

MK04
78x98

MK06
78x118

GAISMAS UN TEMPERATŪRAS KONTROLES KOMPLEKTI

RUĻĻVEIDA ŽALŪZIJAS + SAULESSARGS

ROP (RHL + MHL)	Standarta krāsas	76,61 92,70	88,52 107,10	95,20 115,19
-----------------	------------------	----------------	-----------------	-----------------

RUĻĻVEIDA ŽALŪZIJAS + SAULESSARGS

ROF (RFL + MHL)	Standarta krāsas	99,67 120,60	103,39 125,10	109,34 132,30	115,29 139,50	120,50 145,81	123,47 149,40	121,99 147,60	127,19 153,90
-----------------	------------------	-----------------	------------------	------------------	------------------	------------------	------------------	------------------	------------------

GAISMU NECAURLAIDĪGĀS ŽALŪZIJAS + SAULESSARGS

DOP (DKL + MHL)	Standarta krāsas	105,62 127,81	110,08 133,20	116,78 141,30	122,73 148,51	128,68 155,71	131,65 159,30	129,42 156,60	135,37 163,80
-----------------	------------------	------------------	------------------	------------------	------------------	------------------	------------------	------------------	------------------

ENERGOEFEKTĪVĀS GAISMU NECAURLAIDĪGĀS ŽALŪZIJAS + SAULESSARGS

FOP (FHC + MHL)	Standarta krāsas	124,22 150,30	130,17 157,50	139,10 168,30	144,30 174,60	151,74 183,61	156,20 189,01	152,48 184,50	159,92 193,50
-----------------	------------------	------------------	------------------	------------------	------------------	------------------	------------------	------------------	------------------

DOP/FOP komplektu var pasūtīt ar alumīnija vai baltām sānu sliedēm. Pasūtot vienmēr ir jānorāda nepieciešamais sānu sliežu veids.

Žalūzijām FHC ar baltām sānu sliedēm nav iekļauts montāžas kronšteinu komplekts uzstādīšanai uz iepriekšējās paaudzes jumta logiem.

Bojātu vai iztrūkstošu jumta loga montāžas kronšteinu gadījumā nepieciešams iegādāties ZOZ 230 montāžas komplektu.

RFL/RML/RSL/RHL*

Standarta krāsas

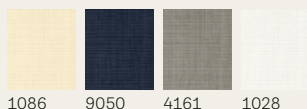

1086 9050 4161 1028

Dizaina krāsas



4163 4162 4069 4164
4165 4166 4168 4167
4171 4169 4170 4155

DKL/DML/DSL/DFD

Standarta krāsas

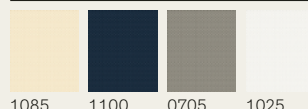

1085 1100 0705 1025

Dizaina krāsas

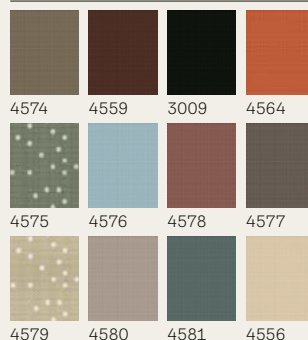

4574 4559 3009 4564
4575 4576 4578 4577
4579 4580 4581 4556

DKL/DFD

Bērnu kolekcija

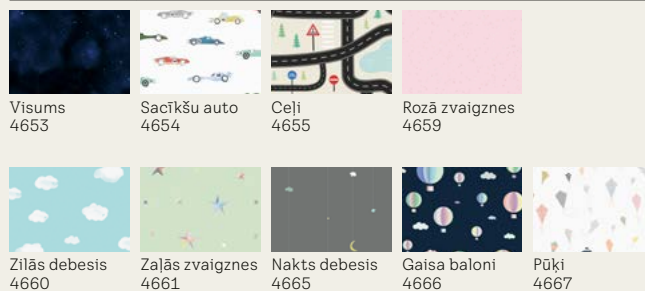

Visums 4653 Sacīkšu auto 4654 Ceļi 4655 Rozā zvaigznes 4659

Zilās debesis 4660 Zaļās zvaigznes 4661 Nakts debesis 4665 Gaisa baloni 4666 Pūķi 4667

* Žalūzijas RHL pieejamas tikai standarta krāsās.

RFY

Dabas kolekcija



Mākoņi 4951 Kāpas 4952 Koki 4953 Klintis 4954

DKY

Dabas kolekcija

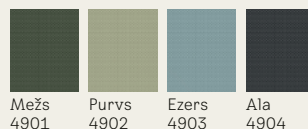







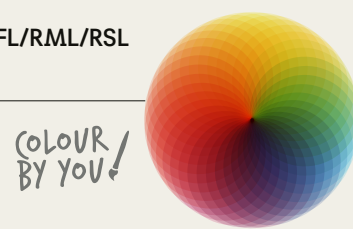

Mežs 4901 Purvs 4902 Ezers 4903 Ala 4904

DKL/DML/DSL/RFL/RML/RSL

Colour by You kolekcija



 MK08 78x140	 MK10 78x160	 PK06 94x118	 PK08 94x140	 PK10 94x160	 SK06 114x118	 SK08 114x140	 UK08 134x140
---	---	---	---	---	--	--	--



IZDEVĪGĀKA CENA, IEGĀDĀJOTIES KOMPLEKTU

95,20 115,19	110,09 133,21	121,99 147,60	132,40 160,20
------------------------	-------------------------	-------------------------	-------------------------

IZDEVĪGĀKA CENA, IEGĀDĀJOTIES KOMPLEKTU

132,40 160,20	142,07 171,90	143,56 173,71	150,99 182,70	156,20 189,01	161,41 195,30	165,13 199,81	182,98 221,40
-------------------------	-------------------------	-------------------------	-------------------------	-------------------------	-------------------------	-------------------------	-------------------------

IZDEVĪGĀKA CENA, IEGĀDĀJOTIES KOMPLEKTU

141,32 170,99	151,73 183,59	152,48 184,50	160,66 194,40	165,87 200,70	171,08 207,01	175,55 212,41	194,88 235,80
-------------------------	-------------------------	-------------------------	-------------------------	-------------------------	-------------------------	-------------------------	-------------------------

IZDEVĪGĀKA CENA, IEGĀDĀJOTIES KOMPLEKTU

167,36 202,50	180,75 218,70	179,26 216,91	189,68 229,51	197,11 238,50	201,57 243,90	206,78 250,21	230,58 279,00
-------------------------	-------------------------	-------------------------	-------------------------	-------------------------	-------------------------	-------------------------	-------------------------

 FHC/FMC/FSC

Standarta krāsas



1045 1047 1163 1156

Dizaina krāsas

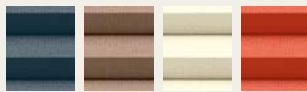

1164 1165 1166 1167



1168 1169 1155 1170

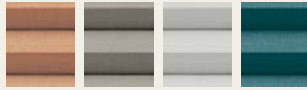

1049 1171 1172 1173

 FHL/FML/FSL

Standarta krāsas

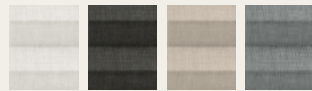

1016 1274 1259 1282

Dizaina krāsas

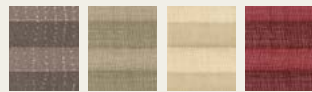

1276 1277 1278 1279



1280 1281 1256 1275



1283 1284 1285 1286

 PAL

Standarta krāsas

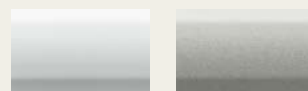

7001 7057

INSEKTU TĪKLS

		A						
		0-438 mm	439-530 mm	531-640 mm	641-760 mm	761-922 mm	923-1120 mm	1121-1285 mm
B	0-1600 mm	ZIL BK04	ZIL CK02	ZIL FK08	ZIL MK06	ZIL PK25	ZIL SK06	ZIL UK04
		380,49 468,00	352,85 434,00	464,23 571,00	464,23 571,00	478,05 588,00	580,49 714,00	594,31 731,00
1601-2000 mm			ZIL CK06	ZIL FK08	ZIL MK06	ZIL PK06	ZIL SK06	ZIL UK10
		-	417,89 514,00	464,23 571,00	464,23 571,00	510,57 628,00	580,49 714,00	715,45 880,00
2001-2400 mm				ZIL FK08	ZIL MK10	ZIL PK10	ZIL SK10	ZIL UK10
		-	-	464,23 571,00	556,91 685,00	589,43 725,00	673,17 828,00	715,45 880,00

Insektu tīkli ir piemēroti šī brīža un iepriekšējās paaudzes VELUX jumta logiem.

Insektu tīkla izmēru kodi atšķiras no logu izmēru kodiem, jo tie ir uzstādīti pie sienas, nevis uz loga rāmja. Tāpēc, lai pasūtītu pareiza izmēra insektu tīklu, jānomēra loga ailes platums un augstums.

Nosakiet pareizo izmēru:

Izmēriet iekšējās sienas platumu (A) un augstumu (B), lai cenu tabulā atrastu sava insektu tīkla izmēra kodu un cenu. Ja jumts ir divi augstumi (B) vai augstumi virs 2400 mm – nepieciešami divi insektu tīkli un viens savienošanas komplekts ZOZ 157 SWL.

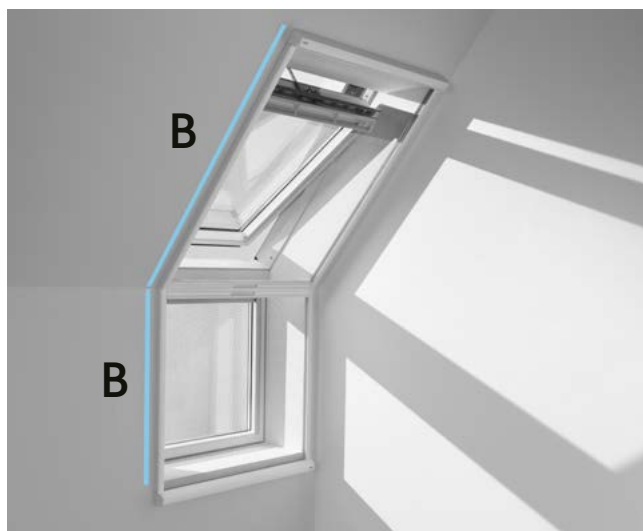
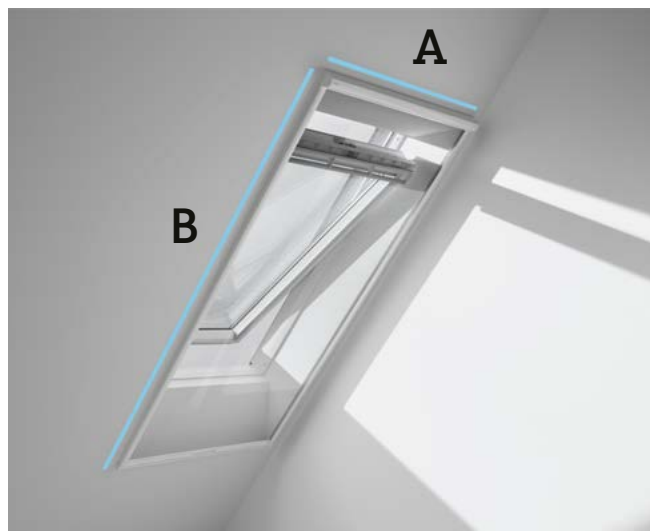

Cenas bez PVN, Euro
Cenas ar PVN, Euro

MK04

PK04

SK04

AIKSARDZĪBA PRET KARSTUMU GDL JUMTA BALKONIEM

MAD	Manuāla	Saulessargs VELUX jumta balkona GDL zemākajam loga elementam	5060	95,87 116,00	104,13 126,00	113,22 137,00
------------	---------	--	------	------------------------	-------------------------	-------------------------

MAD saulesargi ir paredzēti GDL jumta balkona apakšējai daļai. Augšējai daļai ir nepieciešams iegādāties saulesargu MHL.

Cenas bez PVN, Euro
Cenas ar PVN, Euro

MK34

PK34

SK34

UK34

AIKSARDZĪBA PRET KARSTUMU GIL/GIU NEVERAMAJIEM LOGA ELEMENTIEM

MAG	Manuāla	Saulessargs slīpajam loga elementam GIL/GIU	5060	93,39 113,00	106,61 129,00	120,66 146,00	128,93 156,00
------------	---------	---	------	------------------------	-------------------------	-------------------------	-------------------------

MAG saulesargi ir paredzēti GIL/GIU slīpajiem loga elementiem. Augšējai daļai ir nepieciešams iegādāties saulesargu MHL.

Cenas bez PVN, Euro
Cenas ar PVN, Euro

FFKF06

FFKF08

AIKSARDZĪBA PRET KARSTUMU JUMTA LOGIEM TRĪS VIENĀ

SSLS	Solāra	Ruļļveida slēgi VELUX jumta logiem trīs vienā	0000	1 626,45 1 968,00	1 693,38 2 049,00
SSSS	Solāra	Mīkstie slēgi VELUX jumta logiem trīs vienā	0000	1 103,31 1 335,00	1 150,41 1 392,00
MSLS	Solāra	Saulessargi VELUX jumta logiem trīs vienā	5060	870,24 1 053,00	907,44 1 098,00

-90€

Izmēru kods	FK04	FK06	FK08	MK04	MK06	MK08	MK10	PK06	PK08	PK10	SK06	SK08	UK08
Rāmja izmērs, cm	66x98	66x118	66x140	78x98	78x118	78x140	78x160	94x118	94x140	94x160	114x118	114x140	134x140

ĀRĒJĀ AIKSARDZĪBA PRET KARSTUMU KOMPLEKTOS

SOLĀRIE RUĻĻVEIDA SLĒGI + BAROŠANAS BLOKS

IZDEVĪGĀKA CENA, IEGĀDĀJOTIES KOMPLEKTU

SSL	SSL		746,28	768,60	790,91	762,81	790,91	819,01	847,93	836,36	870,25	904,13	881,82	926,45	982,64
S30002	0000	0000	903,00	930,00	957,00	923,00	957,00	991,00	1 026,00	1 012,00	1 053,00	1 094,00	1 067,00	1 121,00	1 189,00

MĪKSTIE SLĒGI AR SOLĀRO VADĪBU + BAROŠANAS BLOKS

IZDEVĪGĀKA CENA, IEGĀDĀJOTIES KOMPLEKTU

SSS	SSS		504,96	516,53	528,93	514,05	528,93	543,80	559,50	552,89	571,07	589,26	577,69	601,65	631,40
S30001	0000	0000	611,00	625,00	640,00	622,00	640,00	658,00	677,00	669,00	691,00	713,00	699,00	728,00	764,00

Jumta logiem, kuri ražoti no 2014. gada											
Loga kods	CK02	CK04	CK06	FK04	FK06	FK08	MK04	MK06			
Slēgi	CK02	CK04	CK06	FK04	FK06	FK08	MK04	MK06			
Žalūzijas/saulessargs ar sliedēm	CK02	CK04	CK06	FK04	FK06	FK08	MK04	MK06			
Žalūzijas/saulessargs ar āķiem	CK00	CK00	CK00	FK00	FK00	FK00	MK00	MK00			
Jumta logiem, kuri ražoti no 2003. līdz 2014. gadam											
Loga kods	C02	C04	C06	F04	F06	F08	M04	M06			
Slēgi	CK02	CK04	CK06	FK04	FK06	FK08	MK04	MK06			
Žalūzijas/saulessargs ar sliedēm	C02	C04	C06	F04	F06	F08	M04	M06			
Žalūzijas/saulessargs ar āķiem	CK00	CK00	CK00	FK00	FK00	FK00	MK00	MK00			
Jumta logiem, kuri ražoti no 1992. līdz 2003. gadam											
Loga kods	102	104	-	204	206	-	304	306			
Slēgi	CK02	CK04	-	FK04	FK06	-	MK04	MK06			
Žalūzijas/saulessargs ar sliedēm	102	104	-	204	206	-	M04	M06			
Žalūzijas/saulessargs ar āķiem	100	100	-	200	200	-	MK00	MK00			
Kods	Darbība		Krāsa	Loga rāmja izmērs (cm)							
				55x78	55x98	55x118	66x98	66x118	66x140	78x98	78x118
Cenas bez PVN, Euro				CK02	CK04	CK06	FK04	FK06	FK08	MK04	MK06
Cenas ar PVN, Euro											

AIZSARDŽĪBA PRET KARSTUMU

Slēgi												
SML	Elektriska	Ruļļveida slēgi	0000	338,84 410,00	358,68 434,00	371,07 449,00	371,07 449,00	386,78 468,00	403,31 488,00	383,47 464,00	403,31 488,00	
SSL	Solāra	Ruļļveida slēgi	0000	474,38 574,00	502,48 608,00	519,83 629,00	519,83 629,00	542,15 656,00	564,46 683,00	536,36 649,00	564,46 683,00	
SMG	Elektriska	Ruļļveida slēgi VELUX jumta logam, kas kombinēts ar VELUX slīpo loga elementu GIL/GIU	0000	-	-	-	816,53 988,00	852,07 1 031,00	887,60 1 074,00	842,98 1 020,00	887,60 1 074,00	
SMH	Elektriska	Ruļļveida slēgi, kas paredzēti elektriskajam VELUX jumta logam GPU	0000	-	-	-	-	542,15 656,00	564,46 683,00	-	564,46 683,00	
Mīkstie slēgi												
SSS	Solāra	Mīkstie slēgi	0000	253,72 307,00	269,42 326,00	278,51 337,00	278,51 337,00	290,08 351,00	302,48 366,00	287,60 348,00	302,48 366,00	
Saulessargs, manuāli vadāms												
MHL	Manuāla	Saulessargs	5060		48,76 59,00			56,20 68,00		60,33 73,00		
MIE	Manuāla	Saulessargs vertikālajam loga elementam VFE	5060		-			-		100,83 122,00		
Saulessargs, ar tālvadības pulti vadāms												
MML	Elektriska	Saulessargs	5060	223,97 271,00	237,19 287,00	244,63 296,00	244,63 296,00	255,37 309,00	266,12 322,00	252,89 306,00	266,12 322,00	
MSL	Solāra	Saulessargs	5060	253,72 307,00	269,42 326,00	278,51 337,00	278,51 337,00	290,08 351,00	302,48 366,00	287,60 348,00	302,48 366,00	

Visi saulesargi un žalūzijas ir piemēroti šī brīža un iepriekšējās paaudzes VELUX jumta logiem. Vienmēr pasūtiet aksesuārus pēc jumta loga koda.

Pašreizējās paaudzes jumta logu izmēra kodā ir burts K, piemēram, MK06, iepriekšējās paaudzes jumta logs bez burta K ir tādā pašā izmērā, piemēram, M06.

Lai pasūtītu slēgus un žalūzijas jumta logiem, kas iegādāti pirms 2002. gada, lūdzam sazināties ar klientu servisu.

Visām elektriskajām darbināmām žalūzijām un slēgiem, kas iegādāti no 01.07.2023, ir 5 gadu garantija.

MHL saulesargs nav saderīgs ar KMG/KSX papildu motora bloku. Un nav uzstādāms jumta logam ar tālvadību.

Elektriskie vadāmie piederumi ir paredzēti savienošanai ar GGL/GGU elektriskajiem jumta logiem vai KUX 110 vadības bloku.

MML/MSL saulesargus logu kombinācijās var uzstādīt tikai, ja logi atrodas 250 mm attālumā viens virs otra un vismaz 18 mm attālumā, ja tie atrodas blakus.

SML/SSL (SMH) slēgus logu kombinācijās vienu virs otra var uzstādīt tikai, ja logi atrodas 250 (300) mm attālumā viens virs otra un vismaz 100 mm attālumā, ja tie atrodas blakus.

SSS mīkstos slēgus logu kombinācijās var uzstādīt tikai, ja logi atrodas 250 mm attālumā viens virs otra un vismaz 18 mm attālumā, ja tie atrodas blakus.

	MK08	MK10	MK12	PK06	PK08	PK10	SK06	SK08	SK10	UK04	UK08	UK10
	MK08	MK10	MK12	PK06	PK08	PK10	SK06	SK08	SK10	UK04	UK08	UK10
	MK08	MK10	MK12	PK06	PK08	PK10	SK06	SK08	SK10	UK04	UK08	UK10
	MK00	MK00	MK12	PK00	PK00	PK00	SK00	SK00	SK00	UK00	UK00	UK00

	M08	M10	M12	P06	P08	P10	S06	S08	S10	U04	U08	U10
	MK08	MK10	MK12	PK06	PK08	PK10	SK06	SK08	SK10	UK04	UK08	UK10
	M08	M10	M12	P06	P08	P10	S06	S08	S10	U04	U08	U10
	MK00	MK00	MK12	PK00	PK00	PK00	SK00	SK00	SK10	UK00	UK00	UK00

	308	310	-	406	408	410	606	608	610	804	808	810
	MK08	MK10	-	PK06	PK08	PK10	SK06	SK08	SK10	UK04	UK08	UK10
	M08	M10	-	P06	P08	P10	S06	S08	S10	U04	U08	U10
	MK00	MK00	-	PK00	PK00	PK00	SK00	SK00	SK00	UK00	UK00	UK00

	78x140	78x160	78x180	94x118	94x140	94x160	114x118	114x140	114x160	134x98	134x140	134x160
	MK08	MK10	MK12	PK06	PK08	PK10	SK06	SK08	SK10	UK04	UK08	UK10

	423,14 512,00	443,80 537,00	504,13 610,00	435,54 527,00	459,50 556,00	484,30 586,00	467,77 566,00	500,00 605,00	523,97 634,00	463,64 561,00	540,50 654,00	580,99 703,00
--	-------------------------	-------------------------	-------------------------	-------------------------	-------------------------	-------------------------	-------------------------	-------------------------	-------------------------	-------------------------	-------------------------	-------------------------

	592,56 717,00	621,49 752,00	705,79 854,00	609,92 738,00	643,80 779,00	677,69 820,00	655,37 793,00	700,00 847,00	733,88 888,00	649,59 786,00	756,20 915,00	813,22 984,00
--	-------------------------	-------------------------	-------------------------	-------------------------	-------------------------	-------------------------	-------------------------	-------------------------	-------------------------	-------------------------	-------------------------	-------------------------

	931,40 1 127,00	976,03 1 181,00	-	957,85 1 159,00	1 011,57 1 224,00	1 064,46 1 288,00	1 028,93 1 245,00	1 100,00 1 331,00	1 153,72 1 396,00	1 020,66 1 235,00	1 189,26 1 439,00	1 277,69 1 546,00
--	---------------------------	---------------------------	---	---------------------------	-----------------------------	-----------------------------	-----------------------------	-----------------------------	-----------------------------	-----------------------------	-----------------------------	-----------------------------

	592,56 717,00	-	-	609,92 738,00	643,80 779,00	-	655,37 793,00	700,00 847,00	-	-	-	-
--	-------------------------	---	---	-------------------------	-------------------------	---	-------------------------	-------------------------	---	---	---	---

	317,36 384,00	333,06 403,00	378,51 458,00	326,45 395,00	344,63 417,00	362,81 439,00	351,24 425,00	375,21 454,00	393,39 476,00	347,93 421,00	404,96 490,00	435,54 527,00
--	-------------------------	-------------------------	-------------------------	-------------------------	-------------------------	-------------------------	-------------------------	-------------------------	-------------------------	-------------------------	-------------------------	-------------------------

	60,33 73,00			70,25 85,00			77,69 94,00				-	
--	-----------------------	--	--	-----------------------	--	--	-----------------------	--	--	--	---	--

	100,83 122,00			117,36 142,00			129,75 157,00				141,32 171,00	
--	-------------------------	--	--	-------------------------	--	--	-------------------------	--	--	--	-------------------------	--

	279,34 338,00	292,56 354,00	333,06 403,00	287,60 348,00	303,31 367,00	319,01 386,00	309,09 374,00	329,75 399,00	346,28 419,00	305,79 370,00	357,02 432,00	383,47 464,00
--	-------------------------	-------------------------	-------------------------	-------------------------	-------------------------	-------------------------	-------------------------	-------------------------	-------------------------	-------------------------	-------------------------	-------------------------

	317,36 384,00	333,06 403,00	378,51 458,00	326,45 395,00	344,63 417,00	362,81 439,00	351,24 425,00	375,21 454,00	393,39 476,00	347,93 421,00	404,96 490,00	435,54 527,00
--	-------------------------	-------------------------	-------------------------	-------------------------	-------------------------	-------------------------	-------------------------	-------------------------	-------------------------	-------------------------	-------------------------	-------------------------



Cenas bez PVN, Euro
Cenas ar PVN, Euro



CK04
55x98



MK04
78x98



MK06
78x118



MK08
78x140



PK04
94x98



SK06
114x118

JUMTA LOGI UN PIESLĒGUMI NELIELAM JUMTA SLĪPUMAM (10°-20°)

W/(m² K) Iebūvēšanas
slīpums

				CK04 55x98	MK04 78x98	MK06 78x118	MK08 78x140	PK04 94x98	SK06 114x118
GBL 2015	Verams ar roku, rokturis augšā, priedes koks, apstrādāts ar trīskāršu pārklājumu, balti krāsots, divkameru stikla pakete	1.1	10-20	413,22 500,00	469,42 568,00	510,74 618,00	546,28 661,00	535,54 648,00	628,10 760,00

Ņemiet vērā! Tikai jumta logs GBL 2015 komplektā ar pieslēgumu EDG nodrošina pareizu, ūdensnecaurlaidīgu un ciešu iebūvēšanu zem 15° jumta slīpuma.

Cenas bez PVN, Euro
Cenas ar PVN, Euro

Izmērs (cm)



CK04
55x98



MK04
78x98



MK06
78x118



MK08
78x140



PK04
94x98



SK06
114x118

PIESLĒGUMI NELIELAM JUMTA SLĪPUMAM (10°-20°) AR PROFILĒTU SEGUMU (LĪDZ 120 MM)

Iebūvēšanas
slīpums









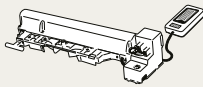
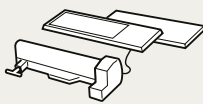

				CK04 55x98	MK04 78x98	MK06 78x118	MK08 78x140	PK04 94x98	SK06 114x118
EDG 1000	Pieslēguma komplekts EDG ar BFX, viena jumta loga GBL iebūvēšanai	10-20	128,10 155,00	143,80 174,00	151,24 183,00	160,33 194,00	161,16 195,00	178,51 216,00	
EDG 1000U	Pieslēguma komplekts EDG ar BFX, viena jumta loga GBL iebūvēšanai betona jumtā	10-20	128,10 155,00	143,80 174,00	151,24 183,00	160,33 194,00	161,16 195,00	178,51 216,00	
EDG 2000	Pieslēguma komplekts EDG ar BDx, viena jumta loga GBL iebūvēšanai	10-20	149,59 181,00	166,94 202,00	175,21 212,00	185,95 225,00	187,60 227,00	207,44 251,00	
EDG 2000U	Pieslēguma komplekts EDG ar BDx, viena jumta loga GBL iebūvēšanai betona jumtā	10-20	149,59 181,00	166,94 202,00	175,21 212,00	185,95 225,00	187,60 227,00	207,44 251,00	

Komplektācijā iekļauta pieslēguma augšējā daļa ar blīvējumu, divas sānu daļas ar blīvējumiem, divas ārējās sānu uzlikas, viena ārējā uzlika loga apakšai, viena pieslēguma apakšējā daļa, difūzijas membrāna un drenāžas noteka. Pieslēguma apakšējā detaļa ir pielāgojama jumta segumam.

ELEKTRISKIE PRODUKTI

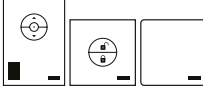
Cenas bez PVN, Eiro

Cenas ar PVN, Eiro

VIEDĀS MĀJAS KONTROLE		
KMG 100K	Elektrisks motors jumta logiem, kas ražoti pēc 2014. gada	 223,97 271,00
KMG 100	Elektrisks motors jumta logiem, kas ražoti pirms 2014. gada	223,97 271,00
KSX 100K WW	Solārs motors jumta logiem, kas ražoti pēc 2014. gada	 300,83 364,00
KSX 100	Solārs motors jumta logiem, kas ražoti pirms 2014. gada	300,83 364,00
KUX 110 EU	Elektriskais barošanas bloks	77,69 94,00
KLI 310	Tālvadības produkta vadības slēdzis	 27,27 33,00
KLI 311	Vadības slēdzis jumta logiem	 27,27 33,00
KLI 312	Vadības slēdzis žalūzijām	 27,27 33,00
KLI 313	Vadības slēdzis slēģiem un saulesargiem	 27,27 33,00
KLR 300	VELUX Touch	 104,96 127,00
KIG 300	VELUX App Control	 100,00 121,00
KIX 300	VELUX ACTIVE iekštelpu klimata kontrole	 199,17 241,00
KLN 300	VELUX ACTIVE vadības slēdzis	 44,63 54,00
KLF 050	Elektriskais vadības bloks	 48,76 59,00
KLB 100	Elektrisks akumulators	 238,84 289,00

Lai jaunākās paaudzes VELUX jumta logus, kas verami ar roku, pārveidotu par elektriski veramiem logiem, jāizvēlas elektriskais vadības bloks KMG 100K + vadības sistēma KUX 110 EU vai solārās vadības sistēma KSX 100K.

KMG un KSX motora bloki ietver arī KLI sienas slēdzi un lietus sensoru. Šie komplekti nav saderīgi ar CK02 izmēra un mazākiem logiem.

Tālvadības žalūziju uzstādīšanas gadījumā DML/RML/FML/FMC uz manuāli vadāmiem jumta logiem vai logiem ar KMG motoru vienmēr ir nepieciešams pasūtīt adapteri ZOZ 241/243. Izvēlieties adaptera veidu atbilstoši VELUX jumta loga paaudzei.

KLF 200 interfeiss nodrošina savienojumu ar ārēju sistēmu un spēj kontrolēt līdz 200 motorizētiem produktiem, kas izvietoti mājā, un ne vairāk kā 5 grupas.

PRODUKTI VELUX JUMTA LOGU UZTURĒŠANAI UN UZLABOŠANAI

NOMAIŅAS STIKLA PAKETES

Nomaiņas stikla paketē IPL ir iekļauta izolēta stikla pakete, kas tiek piegādāta salokāmā kastē ar EPS, kas uzstādīts uz paketes aizsardzībai. Kopā ar stikla paketi tiek piegādāts arī uzstādīšanai nepieciešamie materiāli: skrūves, butils un instrukcija.

Siklojuma variants	Piemērots loga paaudzei	Veids	Ug	Biezums								
Jumta logu paaudzei V21 (ražoti līdz 2014. gadam)					C02	C04	C06	F04	F06	F08	M04	
IPL 0059	V21	Viena kamera	1,1	23.8 mm	82,64 100,00	91,74 111,00	96,69 117,00	99,17 120,00	104,13 126,00	115,70 140,00	110,74 134,00	
IPL 0073G	V21	Viena kamera	1,1	24.4 mm	99,17 120,00	109,92 133,00	115,70 140,00	119,01 144,00	125,62 152,00	138,84 168,00	133,06 161,00	
Jumta logu paaudzei V22 (pieejami šobrīd)					CK02	CK04	CK06	FK04	FK06	FK08	MK04	
IPL 0050	V22	Viena kamera	1,0	23.8 mm	82,64 100,00	91,74 111,00	96,69 117,00	99,17 120,00	104,13 126,00	115,70 140,00	110,74 134,00	
IPL 0061	V22	Divas kameras	0,6	38.6 mm	115,70 140,00	128,10 155,00	- -	138,84 168,00	146,28 177,00	161,98 196,00	155,37 188,00	
IPL 0068	V22	Divas kameras	0,7	37.1 mm	128,10 155,00	142,15 172,00	149,59 181,00	153,72 186,00	161,98 196,00	179,34 217,00	171,90 208,00	

Ja nepieciešams cits stikla paketes modelis, kas nav minēts augstāk esošajā tabulā, vai arī nepieciešams mainīt stikla paketes biežumu, lūdzu, sazinieties ar VELUX klientu servisu, lai noskaidrotu produkta pieejamību un cenu.

Cenas bez PVN, Euro
Cenas ar PVN, Euro

Izmērs (cm) CK00 55x+++ FK00 66x+++ MK00 78x+++ PK00 94x+++ SK00 114x+++ UK00 134x+++

KOMPLEKTI AIZSARDZĪBAI PRET SNIEGU UN LEDU

Iebūvēšanas
slīpums

ZIS 0000	Sniega un ledus servisa komplektu var uzstādīt uz jau iebūvēta jumta loga. Komplekts sastāv no blīvēm, speciāla apakšējā rāmja pārsega un noslēgtām skrūvēm. Šie komponenti padara jumta logu izturīgāku pret sakrājušos ledu un sniegu uz loga un ekstremāliem laikapstākļiem. Piemērots tikai logiem ar divkammeru stikla paketi un tikai sarkanā līmeņa iebūvēšanai.	-	69,42 84,00	69,42 84,00	69,42 84,00	69,42 84,00	69,42 84,00	69,42 84,00
----------	---	---	-----------------------	-----------------------	-----------------------	-----------------------	-----------------------	-----------------------

	M06	M08	M10	P06	P08	P10	S06	S08	S10	U04	U08	U10
	127,27 154,00	137,19 166,00	152,89 185,00	137,19 166,00	146,28 177,00	171,90 208,00	165,29 200,00	169,42 205,00	178,51 216,00	165,29 200,00	193,39 234,00	223,14 270,00
	152,89 185,00	165,29 200,00	183,47 222,00	165,29 200,00	176,03 213,00	205,79 249,00	198,35 240,00	203,31 246,00	214,05 259,00	198,35 240,00	232,23 281,00	266,94 323,00
	MK06	MK08	MK10	PK06	PK08	PK10	SK06	SK08	SK10	UK04	UK08	UK10
	127,27 154,00	137,19 166,00	152,89 185,00	137,19 166,00	146,28 177,00	171,90 208,00	165,29 200,00	169,42 205,00	178,51 216,00	165,29 200,00	193,39 234,00	223,14 270,00
	178,51 216,00	192,56 233,00	214,05 259,00	192,56 233,00	204,96 248,00	- -	231,40 280,00	237,19 287,00	- -	- -	- -	- -
	197,52 239,00	213,22 258,00	236,36 286,00	213,22 258,00	227,27 275,00	266,12 322,00	256,20 310,00	261,98 317,00	276,03 334,00	256,20 310,00	300,00 363,00	345,45 418,00

JUMTA LOGU APKOPE

ZZZ 133KL	Akrila pildviela iespaidumu labošanai logos ar poliuretāna pārklājumu	Šis profesionālais remonta komplekts paredzēts skrāpējumu, iedobumu un citu virsmas bojājumu aizpildīšanai VELUX jumta logiem ar baltu poliuretāna pārklājumu. Ota nav iekļauta komplektā.	26,45 32,00
ZZZ 220/220K	Servisa komplekts VELUX jumta logu apkopei	Kastē ietilpst: <ul style="list-style-type: none"> · Instrukcija · Viena smilšpapīra loksne · Viens 3 m ventilācijas rullis (3,5 x 38 mm) · Viens 3 m gaisa filtra rullis (20 x 20 mm) · Viena smērvielas tūbiņa · Viens atvienošanas instruments Ar komplektu var veikt apkopi 2 līdz 5 VELUX jumta logiem atkarībā no izmēra.	28,93 35,00

GAISMAS TUNEĻI

Cenas bez PVN, Euro
Cenas ar PVN, Euro

Nominālais diametrs (mm)
Izmērs (cm)

OK10
250
37x37

OK14
350
47x47

OK14
350
60x60

GAISMAS TUNEĻI

GAISMAS TUNEĻI AR FISKĒTU CAURULI

TLR 2010	Gaismas tunelis TLR slīpam jumtam ar profilētu segumu, fiksēta caurule, 25 cm	358,68 434,00	-	-
TWR 2010	VELUX gaismas tunelis TWR slīpam jumtam ar profilētu segumu, fiksēta caurule, 25 cm	358,68 434,00	-	-
TLR 2010	Gaismas tunelis TLR slīpam jumtam ar profilētu segumu, fiksēta caurule, 35 cm	-	412,40 499,00	-
TWR 2010	VELUX gaismas tunelis TWR slīpam jumtam ar profilētu segumu, fiksēta caurule, 35 cm	-	412,40 499,00	-
TCR 0010	Gaismas tunelis TCR plakanam jumtam, fiksēta caurule, 35 cm	-	-	532,23 644,00

GAISMAS TUNEĻI AR GOFRĒTU CAURULI

TLF 2010	VELUX gaismas tunelis TLF slīpam jumtam ar plakanu segumu, gofrēta caurule, 35 cm	-	329,75 399,00	-
TWF 2010	Gaismas tunelis TWF slīpam jumtam ar profilētu segumu, gofrēta caurule, 35 cm	-	329,75 399,00	-
TCF 0010	Gaismas tunelis TCF plakanam jumtam, gofrēta caurule, 35 cm	-	-	358,68 434,00

Hidroizolācijas komplekts

BFX 1000	Hidroizolācijas membrāna gaismas tuneļiem	57,85 70,00	57,85 70,00	-
----------	---	-----------------------	-----------------------	---

Cenas bez PVN, Euro
Cenas ar PVN, Euro

OK10

OK14

PAGARINĀJUMA ELEMENTI FIKSĒTĀM CAURULĒM

ZTR 0062	Fiksēts caurules pagarinājums gaismas tuneļiem, 62 cm	63,64 77,00	76,86 93,00
ZTR 0124	Fiksēts caurules pagarinājums gaismas tuneļiem, 124 cm	-	104,96 127,00

UZLABOTAS ENERGOEFEKTIVITĀTES KOMPLEKTS

ZTB 2002	Energoefektivitātes komplekts gaismas tuneļiem	-	42,98 52,00
----------	--	---	-----------------------

Cenas bez PVN, Euro
Cenas ar PVN, Euro

PAGARINĀJUMA RĀMIS PLAKANĀ JUMTA GAISMAS TUNELIM

ZCE 0015	Paaugstinājuma rāmis gaismas tuneļiem TCF/TCR plakaniem jumtiem	156,20 189,00
----------	---	-------------------------

APGAISMOJUMA KOMPLEKTS

ZTL ++	Apgaismojuma komplekts ZTL gaismas tuneļiem	76,86 93,00
--------	---	-----------------------

GAISMAS TUNEĻI AR LAMPAS FUNKCIJU DIENAS UN NAKTS RISINĀJUMI

TCF 0010 + ZTL ++	TCF S00C01	408,26 494,00
TCR 0010P1 + TCR 0010P2 + ZTL ++	TCR S00C01	581,82 704,00
TLF 2010 + ZTL ++	TLF S00C01	379,34 459,00
TLR 2010 + ZTL ++	TLR S00C01	461,98 559,00
TWF 2010 + ZTL ++	TWF S00W01	379,34 459,00
TWR 2010 + ZTL ++	TWR S00W01	461,98 559,00

AKSESUĀRI

Cenas bez PVN, Euro

Cenas ar PVN, Euro

LOGU AKSESUĀRI

Papildus produkti ērtākai lietošanai un drošībai

ZCZ 112	Apkalpes stienis ir ideāli piemērots VELUX jumta logiem ar rokturi vērtnes apakšā, kas tiek uzstādīti neaizsniedzamā vietā. Stienis ir 120 cm garš.	52,89 64,00
ZOZ 012K1	Uzlabo aizsardzību, pievienojot pa centrālo asi veramajiem jumta logiem pretuzlaušanas slēdzeni. Tā novērš logu atvēršanu no iekšpuses bez atslēgas.	20,66 25,00
ZOZ 095	Adapteris neaizsniedzamu VELUX pa centrālo asi veramo jumta logu (GLU, GLL, GZL) vadībai ar apkalpes stienja palīdzību. Paredzēts vecā dizaina augšējām rokturim.	10,74 13,00
ZZZ 181K2	Apakšējais rokturis VELUX jumta logiem, kas verami pa centrālo asi un kuru izmēra kodā ir burts K.	28,10 34,00
ZZZ 237	Piestipriniet celtna āķus abās VELUX jumta loga pusēs, lai viegli, ātri un droši paceltu smagus jumta logus. Pēc piestiprināšanas var pieslēgt celtna pacelšanas siksnas un logu ātri un vienkārši pacelt līdz jumta atvēršanai. Celtna āķus var izmantot ar lielāko daļu VELUX jumta logu tipu līdz 120 kg.	421,49 510,00
ZZZ 244	Ar elastīgajām pārnēsāšanas siksnām divi cilvēki var droši nest lielas un smagas VELUX kastes bez papildu aprīkojuma. Siksnas var izmantot ar visiem VELUX jumta logiem, lai nodrošinātu ērtu pacelšanu un precīzu vadāmību pa šaurām ejām un kāpnēm.	66,12 80,00
ZZZ 258	Atkārtoti lietojamie VELUX rāmja aizsargi ir paredzēti, lai samazinātu bojājumu risku, atkārtoti uzstādot logu tā rāmī. Izgatavots no izturīgas gumijas, trīs aizsargu komplektu var uzstādīt uz jebkura VELUX jumta loga apakšējā un sānu rāmja, lai tas neradītu pēdas rāmī.	27,27 33,00

Cenas bez PVN, Euro

Cenas ar PVN, Euro

ŽALŪZIJU UN SLĒĢU AKSESUĀRI

ZCT 100	Pagarinājums teleskopiskajam apkalpes stienim ZCT 200K, pievienojot tam 100 cm.	19,83 24,00
ZCT 200K	Teleskopiskais apkalpes stienis neaizsniedzamu VELUX pa centrālo asi veramo jumta logu un žalūziju vadībai. 100-180 cm garš. Izmantojot stieni žalūziju vadīšanai, jāpievieno adapteris ZOZ 085.	24,79 30,00
ZCZ 080K	Apkalpes stienis neaizsniedzamu VELUX pa centrālo asi veramo jumta logu un žalūziju vadībai. 80 cm garš. Izmantojot stieni žalūziju vadīšanai, jāpievieno adapteris ZOZ 085.	19,83 24,00
ZOZ 040	Adapteris apkalpes stienim, lai varētu vadīt neaizsniedzamas ruļļveida žalūzijas ar āķiem (RHL).	10,74 13,00
ZOZ 085	Adapteris apkalpes stienim, lai varētu vadīt neaizsniedzamas žalūzijas.	10,74 13,00
ZOZ 157SWL	Produkts divu insektu tīklu savienošanai specifiskas loga ailes gadījumā (skat. 58. lpp.)	19,83 24,00
ZOZ ++	Adaptēra plātne āra produktiem aizsardzībai pret sauli, kas ļauj darbināt žalūzijas un saulesargus jumta logiem ar solāro vadību GGL un GGU	50,41 61,00
ZOZ 217	Projekcijas sviras tiek izmantotas papildu ventilācijai un gaismas pieplūdei, kad ruļļveida slēgi ir nolaisti. Tikai manuālajiem VELUX jumta logiem no 2000. gada (izņemot GTU/GTL).	38,02 46,00
ZOZ 229	Īpaši kronšteini, kas ļauj uzstādīt saulesargus MML-SA un MSL-SA uz VELUX elektriskā loga GPU.	42,15 51,00
ZOZ 230	Žalūziju montāžas kronšteini nepieciešami logiem, kas ražoti pirms 2012. gada.	4,96 6,00
ZOZ 238	ZOZ 238 ir komplekts ārējā aksesuāra SSS-SA, MSL-SA, MML-SA uzstādīšanai uz VELUX jumta logiem, kas ražoti pirms 2000. gada. ZOZ 238 nevar izmantot VELUX jumta logiem, kas ražoti pirms 1992. gada.	24,79 30,00
ZOZ 241	Kabeļu komplekts ir nepieciešams, lai VELUX elektriskās žalūzijas uzstādītu uz manuāli vadāmiem VELUX jumta logiem vai manuāli vadāmiem VELUX jumta logiem, kas ir modernizēti ar motoru. VELUX elektriskās žalūzijas var vadīt ar tālvadības pulti, lai nodrošinātu pilnīgu kontroli pār dabisko apgaismojumu istabā.	19,83 24,00
ZOZ 243	Kabeļu komplekts ir nepieciešams VELUX elektriskajām žalūzijām, kuras jāuzstāda vecākās paaudzes VELUX jumta logiem (VKI/VES/V21).	19,83 24,00
ZOZ 246	Izmanto, uzstādot ar saules enerģiju darbināmus slēgus un saulesargus (SSS vai MSL) uz maziem VELUX ar saules enerģiju darbināmiem jumta logiem (izmēri C un F).	55,37 67,00
ZOZ 250	Vads, ko izmanto solāri vadāmam saulesargam un mīkstajam slēgim (MSL/SSS) uzlādēšanai displejos	9,92 12,00
ZOZ 253	Uzstādīšanas komplekts ruļļveida žalūziju SML/SSL uzstādīšanai jumta logiem, kas ražoti pirms 2000. gada	23,97 29,00
ZOZ 254	Uzstādīšanas komplekts SSL/SML ruļļveida žalūziju SSL/SML uzstādīšanai jumta logiem, kas ražoti no 1942. līdz 2000. gadam	23,97 29,00

Ja tālvadības žalūzijas DML/RML/FML/FMC tiek uzstādītas uz manuāli vadāmiem jumta logiem vai logiem ar KMG motoru, tad vienmēr ir nepieciešams pasūtīt papildu adapteri ZOZ 241/243. Izvēlies adapteri atbilstoši VELUX jumta loga paaudzei.

VIRSGAISMAS LOGI

Cenas bez PVN, Euro
Cenas ar PVN, Euro

Izmērs (cm)*

060060
60x60

080080
80x80

090060
90x60

090090
90x90

100100
100x100

120090
120x90

120120
120x120

150080
150x80

JAUNĀS PAAUDZES VIRSGAISMAS LOGS AR IZLIEKTA STIKLA VIRSMU

Iebūvēšanas slīpums (minimālais) Iebūvēšanas slīpums (maksimālais)

Virsmā

ISU 1093	Izliekta stikla virsmā virsgaismas logam	0	15	466,94 565,00	556,20 673,00	514,88 623,00	618,18 748,00	686,78 831,00	714,05 864,00	892,56 1 080,00	830,58 1 005,00
----------	--	---	----	------------------	------------------	------------------	------------------	------------------	------------------	--------------------	--------------------

Ūrc,ref300 W/(m²K)** Arc,ref300 m²**

Pamatne

CFU 0020Q	Neverama pamatne, vienkameras stikla pakete	0,65	4,4	349,59 423,00	416,53 504,00	385,95 467,00	462,81 560,00	514,05 622,00	534,71 647,00	627,27 759,00	565,29 684,00
CFU 0025Q	Neverama pamatne, divkameru stikla pakete	0,55	4,4	454,55 550,00	541,32 655,00	500,83 606,00	601,65 728,00	668,60 809,00	695,04 841,00	814,88 986,00	734,71 889,00
CVU 0220Q	Elektriski verama pamatne, vienkameras stikla pakete	0,65	4,4	1 042,98 1 262,00	1 109,92 1 343,00	1 079,34 1 306,00	1 156,20 1 399,00	1 207,44 1 461,00	1 228,10 1 486,00	1 320,66 1 598,00	1 258,68 1 523,00
CVU 0225Q	Elektriski verama pamatne, divkameru stikla pakete	0,55	4,4	1 147,93 1 389,00	1 234,71 1 494,00	1 194,21 1 445,00	1 295,04 1 567,00	1 361,98 1 648,00	1 388,43 1 680,00	1 508,26 1 825,00	1 428,10 1 728,00
CVU 0320Q	Solāri verama pamatne, vienkameras stikla pakete	0,65	4,4	1 042,98 1 262,00	1 109,92 1 343,00	1 079,34 1 306,00	1 156,20 1 399,00	1 207,44 1 461,00	1 228,10 1 486,00	1 320,66 1 598,00	1 258,68 1 523,00
CVU 0325Q	Solāri verama pamatne, divkameru stikla pakete	0,55	4,4	1 147,93 1 389,00	1 234,71 1 494,00	1 194,21 1 445,00	1 295,04 1 567,00	1 361,98 1 648,00	1 388,43 1 680,00	1 508,26 1 825,00	1 428,10 1 728,00

Iebūvēšanas piederumi

ZCU 0015	Paaugstinājums ar atloku, 15 cm, saderīgs ar virsgaismas logiem CVU un CFU	260,33 315,00	278,51 337,00	275,21 333,00	290,08 351,00	299,17 362,00	302,48 366,00	334,71 405,00	314,05 380,00
ZCU 1015	Paaugstinājums, 15 cm, bez atloka, saderīgs ar virsgaismas logiem CVU un CFU	233,88 283,00	250,41 303,00	247,93 300,00	261,16 316,00	269,42 326,00	271,90 329,00	301,65 365,00	282,64 342,00
ZZZ 210U	Nostiprināšanas komplekts virsgaismas logiem CVU/CFU	57,02 69,00	61,16 74,00	60,33 73,00	63,64 77,00	66,12 80,00	66,12 80,00	73,55 89,00	69,42 84,00
BBX 0000	Tvaika barjera virsgaismas logiem	21,49 26,00	23,14 28,00	23,14 28,00	23,97 29,00	24,79 30,00	24,79 30,00	28,10 34,00	26,45 32,00
LSF 2000	Ailes apdare virsgaismas logiem	268,60 325,00	287,60 348,00	294,21 356,00	307,44 372,00	326,45 395,00	319,83 387,00	345,45 418,00	329,75 399,00

* Visiem taisnstūrveida izmēriem (ar elektrisko vai saules enerģiju) loga eņģes novietotas garākajā pusē.

** Aprēķināts izmēram 120x120 cm ar 300 mm paaugstinājumu 0° jumta slīpumā.

	 150100 150x100	 150120 150x120	 150150 150x150	 200060 200x60	 200100 200x100
	906,61 1 097,00	1 064,46 1 288,00	1 235,54 1 495,00	940,50 1 138,00	1 297,52 1 570,00
	642,98 778,00	724,79 877,00	842,98 1 020,00	642,98 778,00	884,30 1 070,00
	835,54 1 011,00	942,15 1 140,00	1 095,87 1 326,00	835,54 1 011,00	1 149,59 1 391,00
	1 336,36 1 617,00	1 418,18 1 716,00	1 536,36 1 859,00	1 336,36 1 617,00	1 577,69 1 909,00
	1 528,93 1 850,00	1 635,54 1 979,00	1 789,26 2 165,00	1 528,93 1 850,00	1 842,98 2 230,00
	1 336,36 1 617,00	1 418,18 1 716,00	1 536,36 1 859,00	1 336,36 1 617,00	1 577,69 1 909,00
	1 528,93 1 850,00	1 635,54 1 979,00	1 789,26 2 165,00	1 528,93 1 850,00	1 842,98 2 230,00
	347,11 420,00	374,38 453,00	406,61 492,00	358,68 434,00	428,10 518,00
	312,40 378,00	336,36 407,00	366,12 443,00	323,14 391,00	385,12 466,00
	76,03 92,00	82,64 100,00	89,26 108,00	79,34 96,00	94,21 114,00
	28,93 35,00	28,93 35,00	29,75 36,00	28,93 35,00	32,23 39,00
	352,07 426,00	357,85 433,00	383,47 464,00	367,77 445,00	400,00 484,00

Cenas bez PVN, Euro
Cenas ar PVN, Euro

Izmērs (cm)*

060060
60x60

080080
80x80

090060
90x60

090090
90x90

100100
100x100

120090
120x90

120120
120x120

150080
150x80

JAUNĀS PAAUDZES VIRSGAISMAS LOGS AR PLAKANA STIKLA VIRSMU

Iebūvēšanas slīpums (minimālais) Iebūvēšanas slīpums (maksimālais)

Virsmā

ISU 2093	Plakana stikla virsmā	2	15	337,19 408,00	401,65 486,00	371,90 450,00	446,28 540,00	495,87 600,00	515,70 624,00	644,63 780,00	600,00 726,00
----------	-----------------------	---	----	-------------------------	-------------------------	-------------------------	-------------------------	-------------------------	-------------------------	-------------------------	-------------------------

Urc.ref300 W/(m²K)** Arc.ref300 m²**

Pamatne

CFU 0020Q	Neverama pamatne, vienkameras stikla pakete	0.75	4.1	349,59 423,00	416,53 504,00	385,95 467,00	462,81 560,00	514,05 622,00	534,71 647,00	627,27 759,00	565,29 684,00
CFU 0025Q	Neverama pamatne, divkameru stikla pakete	0.60	4.1	454,55 550,00	541,32 655,00	500,83 606,00	601,65 728,00	668,60 809,00	695,04 841,00	814,88 986,00	734,71 889,00
CVU 0220Q	Elektriski verama pamatne, vienkameras stikla pakete	0.75	4.1	1 042,98 1 262,00	1 109,92 1 343,00	1 079,34 1 306,00	1 156,20 1 399,00	1 207,44 1 461,00	1 228,10 1 486,00	1 320,66 1 598,00	1 258,68 1 523,00
CVU 0225Q	Elektriski verama pamatne, divkameru stikla pakete	0.60	4.1	1 147,93 1 389,00	1 234,71 1 494,00	1 194,21 1 445,00	1 295,04 1 567,00	1 361,98 1 648,00	1 388,43 1 680,00	1 508,26 1 825,00	1 428,10 1 728,00
CVU 0320Q	Solāri verama pamatne, vienkameras stikla pakete	0.75	4.1	1 042,98 1 262,00	1 109,92 1 343,00	1 079,34 1 306,00	1 156,20 1 399,00	1 207,44 1 461,00	1 228,10 1 486,00	1 320,66 1 598,00	1 258,68 1 523,00
CVU 0325Q	Solāri verama pamatne, divkameru stikla pakete	0.60	4.1	1 147,93 1 389,00	1 234,71 1 494,00	1 194,21 1 445,00	1 295,04 1 567,00	1 361,98 1 648,00	1 388,43 1 680,00	1 508,26 1 825,00	1 428,10 1 728,00

Iebūvēšanas piederumi

ZCU 0015	Paaugstinājums ar atloku, 16 cm, saderīgs ar virsgaismas logiem CVU un CFU	260,33 315,00	278,51 337,00	275,21 333,00	290,08 351,00	299,17 362,00	302,48 366,00	334,71 405,00	314,05 380,00
ZCU 1015	Paaugstinājums, 16 cm, bez atloka, saderīgs ar virsgaismas logiem CVU un CFU	233,88 283,00	250,41 303,00	247,93 300,00	261,16 316,00	269,42 326,00	271,90 329,00	301,65 365,00	282,64 342,00
ZZZ 210U	Nostiprināšanas komplekts virsgaismas logiem CVU/CFU	57,02 69,00	61,16 74,00	60,33 73,00	63,64 77,00	66,12 80,00	66,12 80,00	73,55 89,00	69,42 84,00
BBX 0000	Tvaika barjera virsgaismas logiem	21,49 26,00	23,14 28,00	23,14 28,00	23,97 29,00	24,79 30,00	24,79 30,00	28,10 34,00	26,45 32,00
LSF 2000	Ailes apdare virsgaismas logiem	268,60 325,00	287,60 348,00	294,21 356,00	307,44 372,00	326,45 395,00	319,83 387,00	345,45 418,00	329,75 399,00

* Visiem taisnstūrveida izmēriem (ar elektrisko vai saules enerģiju) loga eņģes novietotas garākajā pusē.

** Aprēķināts izmēram 120x120 cm ar 300 mm paaugstinājumu 0° jumta slīpumā.

Cenas bez PVN, Euro
Cenas ar PVN, Euro

060060

080080

090060

090090

100100

120090

120120

150080

ŽALŪZIJAS JAUNĀS PAAUDZES VIRSGAISMAS LOGIEM

DSU	Gaismu necaurīdīgās žalūzijas, solārā vadība	318,18 385,00	332,23 402,00	324,79 393,00	338,84 410,00	346,28 419,00	352,89 427,00	359,50 435,00	356,20 431,00
MSU	Saulessargs, solārā vadība	318,18 385,00	332,23 402,00	324,79 393,00	338,84 410,00	346,28 419,00	352,89 427,00	359,50 435,00	356,20 431,00
ZIU	Insektu tīkls, manuālā vadība	79,34 96,00	82,64 100,00	80,99 98,00	85,12 103,00	86,78 105,00	88,43 107,00	90,08 109,00	89,26 108,00

Saulessargi un gaismu necaurīdīgās žalūzijas ir novietotas jumta loga iekšpusē. Mēs iesakām uzstādīt aksesuārus jumta loga iebūvēšanas laikā. Produkti ir savienojami ar jaunās paaudzes CVU un CFU virsgaismas logiem ar plakānu un izliektu stiklu. Saulessargu un žalūzijas var kombinēt ar insektu tīklu. Nav iespējams apvienot saulessargu ar žalūziju

	 150100 150x100	 150120 150x120	 150150 150x150	 200060 200x60	 200100 200x100
	654,55 792,00	767,77 929,00	891,74 1 079,00	679,34 822,00	936,36 1 133,00
	642,98 778,00	724,79 877,00	842,98 1 020,00	642,98 778,00	884,30 1 070,00
	835,54 1 011,00	942,15 1 140,00	1 095,87 1 326,00	835,54 1 011,00	1 149,59 1 391,00
	1 336,36 1 617,00	1 418,18 1 716,00	1 536,36 1 859,00	1 336,36 1 617,00	1 577,69 1 909,00
	1 528,93 1 850,00	1 635,54 1 979,00	1 789,26 2 165,00	1 528,93 1 850,00	1 842,98 2 230,00
	1 336,36 1 617,00	1 418,18 1 716,00	1 536,36 1 859,00	1 336,36 1 617,00	1 577,69 1 909,00
	1 528,93 1 850,00	1 635,54 1 979,00	1 789,26 2 165,00	1 528,93 1 850,00	1 842,98 2 230,00
	347,11 420,00	374,38 453,00	406,61 492,00	358,68 434,00	428,10 518,00
	312,40 378,00	336,36 407,00	366,12 443,00	323,14 391,00	385,12 466,00
	76,03 92,00	82,64 100,00	89,26 108,00	79,34 96,00	94,21 114,00
	28,93 35,00	28,93 35,00	29,75 36,00	28,93 35,00	32,23 39,00
	352,07 426,00	357,85 433,00	383,47 464,00	367,77 445,00	400,00 484,00

	150100	150120	150150	200060	200100
	366,94 444,00	394,21 477,00	432,23 523,00	387,60 469,00	452,89 548,00
	366,94 444,00	394,21 477,00	432,23 523,00	387,60 469,00	452,89 548,00
	91,74 111,00	98,35 119,00	108,26 131,00	96,69 117,00	113,22 137,00

Cenas bez PVN, Euro												
Cenas ar PVN, Euro												
Izmērs (cm)*	060060 60x60	060090 60x90	080080 80x80	090090 90x90	090120 90x120	100100 100x100	100150 100x150	120120 120x120	150150 150x150			

VIRSGAISMAS LOGS AR KUPOLA VIRSMU

				Iebūvēšanas slīpums (minimālais)		Iebūvēšanas slīpums (maksimālais)							
Virsmas													
ISD 0000	Caurspīdīgs akrila kupols	0	15	188,43 228,00	207,44 251,00	223,97 271,00	249,59 302,00	287,60 348,00	276,86 335,00	365,29 442,00	360,33 436,00	498,35 603,00	
ISD 0010	Caurspīdīgs polikarbonāta kupols	0	15	203,31 246,00	223,97 271,00	242,15 293,00	269,42 326,00	310,74 376,00	299,17 362,00	395,04 478,00	388,43 470,00	538,02 651,00	
ISD 0100	Pienbalts akrila kupols	0	15	188,43 228,00	207,44 251,00	223,97 271,00	249,59 302,00	287,60 348,00	276,86 335,00	365,29 442,00	360,33 436,00	498,35 603,00	
ISD 0110	Pienbalts polikarbonāta kupols	0	15	203,31 246,00	223,97 271,00	242,15 293,00	269,42 326,00	310,74 376,00	299,17 362,00	395,04 478,00	388,43 470,00	538,02 651,00	

Ūv vērtība W/(m²K)**

Pamatne													
CFP 0073QV	Neverama pamatne, izturīga pret ielaušanos, vienkameras stikla pakete	0.80		349,59 423,00	385,95 467,00	416,53 504,00	462,81 560,00	534,71 647,00	514,05 622,00	642,98 778,00	627,27 759,00	842,98 1 020,00	
CFP 0073	Neverama pamatne, vienkameras stikla pakete	0.87		283,47 343,00	312,40 378,00	337,19 408,00	374,38 453,00	433,06 524,00	416,53 504,00	520,66 630,00	508,26 615,00	682,64 826,00	
CVP 0073U	Manuāli darbināma pamatne, divkameru stikla pakete	0.87		478,51 579,00	514,88 623,00	545,45 660,00	591,74 716,00	663,64 803,00	642,98 778,00	771,90 934,00	756,20 915,00	-	
CVP 0573	Elektriski darbināma pamatne	0.87		698,35 845,00	734,71 889,00	765,29 926,00	811,57 982,00	883,47 1 069,00	862,81 1 044,00	991,74 1 200,00	976,03 1 181,00	1 191,74 1 442,00	
CVP 0673QV	Elektriski darbināma pamatne, izturīga pret ielaušanos	0.80		1 016,53 1 230,00	1 052,89 1 274,00	1 083,47 1 311,00	1 129,75 1 367,00	1 201,65 1 454,00	1 180,99 1 429,00	1 309,92 1 585,00	1 294,21 1 566,00	1 509,92 1 827,00	

Iebūvēšanas piederumi

BBX 0000	Tvaika barjera virsgaismas logiem			21,49 26,00	23,14 28,00	23,14 28,00	23,97 29,00	24,79 30,00	24,79 30,00	28,93 35,00	28,10 34,00	29,75 36,00	
LSF 2000***	Ailes apdare virsgaismas logiem			268,60 325,00	287,60 348,00	294,21 356,00	307,44 372,00	326,45 395,00	319,83 387,00	352,07 426,00	345,45 418,00	383,47 464,00	
ZCE 0015	Paaugstinājums ar atloku, 16 cm			260,33 315,00	275,21 333,00	278,51 337,00	290,08 351,00	302,48 366,00	299,17 362,00	347,11 420,00	334,71 405,00	406,61 492,00	
ZCE 1015	Paaugstinājums, bez atloka, 16 cm			233,88 283,00	247,93 300,00	250,41 303,00	261,16 316,00	271,90 329,00	269,42 326,00	312,40 378,00	301,65 365,00	366,12 443,00	
ZZZ 210	Nostiprināšanas komplekts			57,02 69,00	60,33 73,00	61,16 74,00	63,64 77,00	66,12 80,00	66,12 80,00	76,03 92,00	73,55 89,00	89,26 108,00	

* Visiem taisnstūra izmēriem (ar elektrisko un saules enerģiju) eņģes atrodas īsajā pusē.

** Aprēķināts izmēram 120x120 cm ar 300 mm paaugstinājumu 0° jumta slīpumā.

*** Šis universālais risinājums ietver PVC paneļus un tvaika barjeru.

Cenas bez PVN, Euro												
Cenas ar PVN, Euro												
	060060	060090	080080	090090	090120	100100	100150	120120	150150			

ŽALŪZIJAS VIRSGAISMAS LOGAM AR KUPOLA VIRSMU

FMG	Plisētās žalūzijas, elektriski vadāmas	240,50 291,00	245,45 297,00	250,41 303,00	256,20 310,00	266,12 322,00	261,16 316,00	276,86 335,00	271,90 329,00	-
FMK	Gaismu necaurīdīgās enerģoefektīvās žalūzijas, elektriski vadāmas	269,42 326,00	275,21 333,00	280,99 340,00	286,78 347,00	298,35 361,00	292,56 354,00	310,74 376,00	304,13 368,00	366,12 443,00
FSK	Gaismu necaurīdīgās enerģoefektīvās žalūzijas, solāri vadāmas	269,42 326,00	275,21 333,00	280,99 340,00	286,78 347,00	298,35 361,00	292,56 354,00	310,74 376,00	304,13 368,00	366,12 443,00
MSG	Saulessargs, solāri vadāms	265,29 321,00	271,07 328,00	276,86 335,00	282,64 342,00	294,21 356,00	288,43 349,00	305,79 370,00	300,00 363,00	-

Uzstādot elektriski darbināmās žalūzijas uz CFP neveramā virsgaismas loga, nepieciešams iegādāties arī KUX 110 vadības bloku.

Žalūziju krāsu kodi: FMG: 1016 – balta, 1259 – smilšu krāsa, FMK/FSK: 1045 – balta, 1047 – melna.

MSG un FSK nevar uzstādīt ar necaurredzamo kupolu.

FMK/FMG/FSK var kombinēt ar solāro saulessargu MSG.

Cenas bez PVN, Euro													
Cenas ar PVN, Euro													
Izmērs (cm)*	060060 60x60	080080 80x80	090060 90x60	090090 90x90	100100 100x100	120090 120x90	120120 120x120	150100 150x100	150150 150x150	200100 200x100			

KUPOLS

Iebūvēšanas slīpums (minimālais) Iebūvēšanas slīpums (maksimālais)

Virsmas													
ISJ 0102	Divu slāņu akrila kupols, necaurredzams	0	15	157,02 190,00	187,60 227,00	173,55 210,00	208,26 252,00	231,40 280,00	240,50 291,00	300,83 364,00	305,79 370,00	416,53 504,00	437,19 529,00
ISJ 0103	Trīs slāņu akrila kupols, necaurredzams	0	15	212,40 257,00	252,89 306,00	234,71 284,00	280,99 340,00	312,40 378,00	324,79 393,00	405,79 491,00	412,40 499,00	561,98 680,00	590,08 714,00
ISJ 0112	Divu slāņu polikarbonāta kupols, necaurredzams	0	15	180,99 219,00	215,70 261,00	200,00 242,00	239,67 290,00	266,12 322,00	276,86 335,00	346,28 419,00	351,24 425,00	479,34 580,00	503,31 609,00
ISJ 0113	Trīs slāņu polikarbonāta kupols, necaurredzams	0	15	243,80 295,00	290,91 352,00	269,42 326,00	323,14 391,00	358,68 434,00	372,73 451,00	466,12 564,00	473,55 573,00	645,45 781,00	677,69 820,00

Uw vērtība ar divu slāņu virsmu W/(m²K)** Uw vērtība ar trīs slāņu virsmu W/(m²K)**

Pamatne													
CFJ 0010	Neverama pamatne, 15 cm	2.2	1.7	233,88 283,00	278,51 337,00	257,85 312,00	309,09 374,00	343,80 416,00	357,85 433,00	419,83 508,00	429,75 520,00	563,64 682,00	591,74 716,00
CFJ 1010	Neverama pamatne, 30 cm	2.2	1.7	292,56 354,00	347,93 421,00	322,31 390,00	386,78 468,00	429,75 520,00	447,11 541,00	523,97 634,00	537,19 650,00	704,96 853,00	-
CFJ 2020	Neverama pamatne, 50 cm	2.1	1.7	538,02 651,00	640,50 775,00	593,39 718,00	711,57 861,00	790,91 957,00	822,31 995,00	964,46 1 167,00	988,43 1 196,00	1 296,69 1 569,00	-
CVJ 0210	Elektriski vadāma pamatne, 15 cm	2.0	1.6	835,54 1 011,00	880,17 1 065,00	859,50 1 040,00	910,74 1 102,00	945,45 1 144,00	959,50 1 161,00	1 021,49 1 236,00	1 031,40 1 248,00	1 165,29 1 410,00	1 193,39 1 444,00
CVJ 1210	Elektriski vadāma pamatne, 30 cm	2.0	1.6	932,23 1 128,00	976,86 1 182,00	956,20 1 157,00	1 007,44 1 219,00	1 042,15 1 261,00	1 056,20 1 278,00	1 118,18 1 353,00	1 128,10 1 365,00	1 261,98 1 527,00	-
CVJ 2220	Elektriski vadāma pamatne, 50 cm	2.0	1.6	1 310,74 1 586,00	1 355,37 1 640,00	1 334,71 1 615,00	1 385,95 1 677,00	1 420,66 1 719,00	1 434,71 1 736,00	1 496,69 1 811,00	1 506,61 1 823,00	1 640,50 1 985,00	-

Iebūvēšanas piederumi

ZCJ 0000	Nomaiņas rāmis kupolam			154,55 187,00	169,42 205,00	161,98 196,00	178,51 216,00	185,95 225,00	193,39 234,00	221,49 268,00	239,67 290,00	-	-
ZCJ 1112	Nomaiņas komplekts manuālai vēršanai			386,78 468,00	386,78 468,00	386,78 468,00	386,78 468,00	386,78 468,00	386,78 468,00	386,78 468,00	386,78 468,00	-	-
ZCJ 1210	Nomaiņas komplekts elektriskai vēršanai			601,65 728,00	601,65 728,00	-	601,65 728,00	601,65 728,00	-	601,65 728,00	-	-	-
ZZZ 210J	Nostiprināšanas komplekts			59,50 72,00	63,64 77,00	62,81 76,00	66,94 81,00	68,60 83,00	69,42 84,00	76,86 93,00	79,34 96,00	93,39 113,00	-
ZZZ 257	Aizsardzības režģis			76,86 93,00	109,92 133,00	99,17 120,00	129,75 157,00	150,41 182,00	156,20 189,00	194,21 235,00	203,31 246,00	273,55 331,00	-

* Visiem tainstūra izmēriem (ar elektrisko un saules enerģiju) loga eņģes atrodas garākajā pusē.

** Aprēķināts izmēram 120x120 cm ar 300 mm paaugstinājumu 0° jumta slīpumā.



Cenas bez PVN, Euro
Cenas ar PVN, Euro

MK04 78x98	MK06 78x118	MK08 78x140	PK06 94x118	PK08 94x140	SK06 114x118	SK08 114x140	UK04 134x98

DŪMU LŪKAS

		W/(m ² K) Iebūvēšanas slīpums										
GGL 307040D	Priedes koks, apstrādāts ar trīskāršu pārklājumu, caurspīdīgs lakojums, vienkameras stikla pakete	1.3	15-60	741,32 897,00	774,38 937,00	803,31 972,00	843,80 1021,00	876,86 1061,00	868,60 1051,00	925,62 1120,00	880,17 1065,00	
GGL 306640D	Priedes koks, apstrādāts ar trīskāršu pārklājumu, caurspīdīgs lakojums, divkameru stikla pakete	1.0	15-60	891,74 1079,00	938,02 1135,00	977,69 1183,00	1034,71 1252,00	1080,99 1308,00	1069,42 1294,00	1148,76 1390,00	1085,95 1314,00	
GGU 007040D	Balts poliuretāns ap koka kodolu ar papildu izturīgu pārklājumu, vienkameras stikla pakete	1.3	15-60	835,54 1011,00	876,86 1061,00	912,40 1104,00	962,81 1165,00	1004,13 1215,00	994,21 1203,00	1065,29 1289,00	1009,09 1221,00	
GGU 006640D	Balts poliuretāns ap koka kodolu ar papildu izturīgu pārklājumu, divkameru stikla pakete	1.0	15-60	1023,14 1238,00	1080,99 1308,00	1130,58 1368,00	1201,65 1454,00	1259,50 1524,00	1244,63 1506,00	1344,63 1627,00	1266,12 1532,00	

Pieslēgums jāiegādājas atsevišķi.

ģeometriskais laukums Av, m ² (laukums ir vienāds lūkām ar un bez deflektoriem)	0,63	0,77	0,92	0,95	1,14	1,17	1,40	1,13
Aktīvais laukums Aa, m ² , dūmu lūkai ar deflektoru	0,36	0,46	0,59	0,53	0,68	0,61	0,77	0,54
Aktīvais laukums Aa, m ² , dūmu lūkai bez deflektora	0,19	0,29	0,43	0,30	0,46	0,28	0,44	0,16

Cenas bez PVN, Euro
Cenas ar PVN, Euro

Izmērs (cm)*	090120 90x120	100100 100x100	120120 120x120

Cenas bez PVN, Euro
Cenas ar PVN, Euro

ĪPAŠU FUNKCIJU JUMTA LOGI PLAKANIEM JUMTIEM

		Iebūvēšanas slīpums (minimālais)		Iebūvēšanas slīpums (maksimālais)		
Virsma						
ISD 0000	Caurspīdīgs akrila kupols	0	15	287,60 348,00	276,86 335,00	360,33 436,00
ISD 0010	Caurspīdīgs polikarbonāta kupols	0	15	310,74 376,00	299,17 362,00	388,43 470,00
ISD 0100	Necaurredzams akrila kupols	0	15	287,60 348,00	276,86 335,00	360,33 436,00
ISD 0110	Necaurredzams polikarbonāta kupols	0	15	310,74 376,00	299,17 362,00	388,43 470,00
Ūv vērtība W/(m²K)**						
Pamatne						
CXP 0473Q	Manuāli darbināma pamatne jumta lūkai	0,86		1 069,42 1 294,00	1 028,10 1 244,00	1 254,55 1 518,00
CSP 1073Q	Dūmu lūka	0,99		-	1 876,03 2 270,00	2 289,26 2 770,00
Iebūvēšanas piederumi						
BBX 0000	Tvaika barjera virsgaismas logiem			24,79 30,00	24,79 30,00	28,10 34,00
LSF 2000***	Ailes apdare virsgaismas logiem			326,45 395,00	319,83 387,00	345,45 418,00
ZCE 0015****	Paaugstinājums ar atloku, 15 cm			302,48 366,00	299,17 362,00	334,71 405,00
ZCE 1015****	Paaugstinājums, bez atloka, 15 cm			271,90 329,00	269,42 326,00	301,65 365,00
ZZZ 210	Nostiprināšanas komplekts			66,12 80,00	66,12 80,00	73,55 89,00

PIEDERUMI DŪMU LŪKĀM

KFA 100 WW	VELUX dūmu detektors KFA 100		157,02 190,00
KFC 210 EU	VELUX vadības ierīce KFC 210		828,10 1 002,00
KFC 220 EU	VELUX vadības ierīce KFC 220		1 071,07 1 296,00
KFK 100 WW	VELUX vadības slēdzis KFK 100		157,02 190,00
KFK 200 WW	VELUX ventilācijas slēdzis KFK 200		157,02 190,00
KFX 210 EU	VELUX vadības sistēma KFX 210		972,73 1 177,00
KLA 200 WW	VELUX lietus sensors KLA 200		77,69 94,00

* Visiem taisnstūra izmēriem (ar elektrisko un saules enerģiju) loga enģes atrodas īsākajā pusē.

** Aprēķināts izmēram 120x120 cm ar 300 mm paaugstinājumu 0° jumta slīpumā.

*** Šis universālais risinājums ietver PVC paneļus, tvaika barjeru un pieslēgumus.

**** Nav savienojams ar CSP.

CXP nevar uzstādīt žalūzijas.

CSP nav saderīgs ar FMG un FMK. MSG un FSK var uzstādīt uz CSP.

UK08
134x140

990,91
1 199,00

1 240,50
1 501,00

1 147,11
1 388,00

1 459,50
1 766,00

1,67

0,83

0,38

Klasifikācija atbilstoši Eiropas standartam par dūmu un karstu- ma izplūdes ventilatoriem EN 12101-3

Īpašības	Vērtība	
Darbības uzticamība (Re)	Re 1 000 + 10 000	
Atvēršanās zem slodzes (SL)	Slīpam jumtam: Visiem izmēriem = SL1000	Plakanam jumtam: Izmēram 100x100 = SL1000 Izmēram 120x120 = SL500
Zema apkārtējā temperatūra	T (-15)	
Stabilitāte zem vēja slodzes (WL)	WL 3000	
Izturība pret karstumu (B)	B 300	
Reakcija pret uguni (V)	Reakcija pret uguni GGL 40D: C-s1, d2 Reakcija pret uguni GGÜ 40D: D-s2, d2 Reakcija pret uguni CSP: B-S1, d0	

Lai iegūtu vairāk informācijas, apmeklējiet vietni velux.lv. Mēs paturam tiesības veikt izmaiņas specifikācijās.

Elektroinstalācijas shēma slīpam jumtam

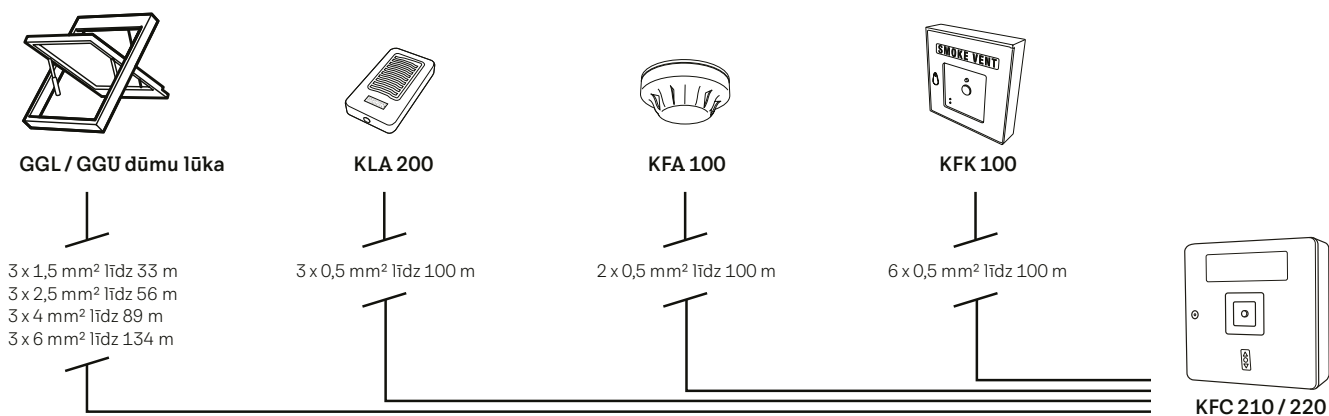

Elektroinstalācijas shēma plakanam jumtam

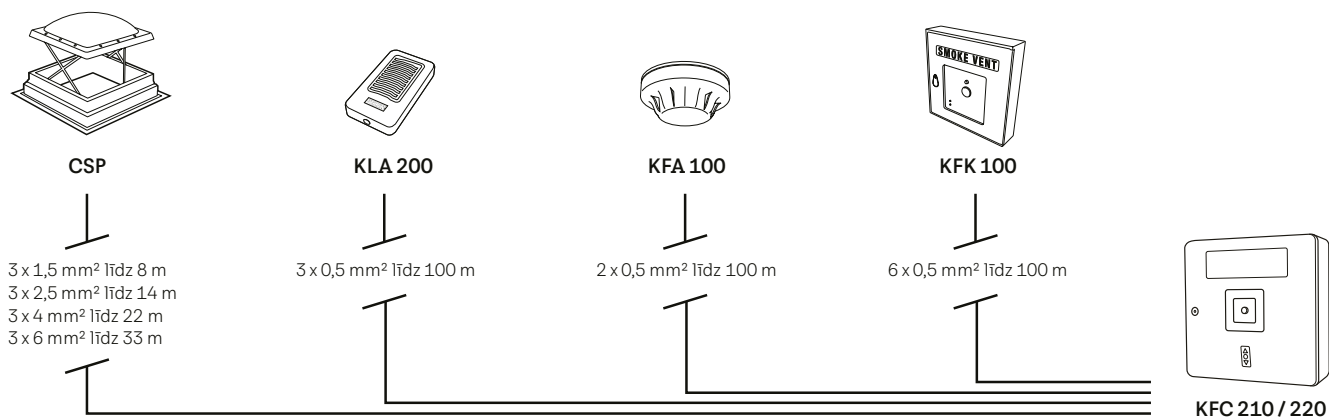

Mēs pārveidojam telpas kopš 1941. gada. Vairāk nekā 80 gadus, VELUX ir palīdzējis cilvēkiem iedomāties un pārveidot telpas, izmantojot dienasgaismu un svaigu gaisu caur jumtu. Mūsu produktu klāstā ietilpst jumta logi, dekoratīvās žalūzijas, saulesargi un slēdži, kā arī iebūvēšanas piederumi un viedās mājas risinājumi. Radot gaišāku, veselīgāku, ilgtspējīgāku vietu, kur dzīvot, strādāt, mācīties un spēlēties, mēs piedāvājam uzlabot ikviena ikdienas dzīvi visā pasaulē. Mēs strādājam globāli gan pārdošanā, gan ražošanā. Mēs trādājam vairāk nekā 40 valstīs, un mums ir ap 11 500 darbinieku visā pasaulē. VELUX grupa pieder sabiedrībai ar ierobežotu atbildību VKR Holding A/S, kas pilnībā pieder bezpeļņas labdarības fondiem (VELUX FOUNDATIONS) un ģimenei. Lai iegūtu papildinformāciju, apmeklējiet vietni velux.com.

VELUX Latvia SIA
Liepājas iela 34
LV-1002, Rīga

Tel: 80 00 88 02

E-pasts: velux.latvia@velux.com
Mājaslapa: www.velux.lv

www.facebook.com/VELUXLatvia
www.youtube.com/@VELUXLatvia

